



HYDRAULICS

CANGZHOU QC HYDRAULICS CO., LTD

沧州乾程液压器材有限公司



STAINLESS STEEL METRIC DIN 2353 TUBE FITTINGS

QC HYDRAULICS IS A STAINLESS STEEL MANUFACTURER

» 2021

HEBEI CHINA 中国·河北



沧州乾程液压器材有限公司
CANGZHOU QC HYDRAULICS CO., LTD



COMPANY INTRODUCTION

Cangzhou QC Hydraulics Co., Ltd was established in 1999, Over the years, QC Hydraulics has been developing into one of the world's most important manufacturers of stainless steel components. QC Hydraulics fittings meet or exceed SAE, JIC, DIN, ISO, JIS and international standards.

QC Hydraulics has a large products range for selection:

- SS one piece crimp hose fittings
- SS swaged hose fittings
- SS hydraulic adapters
- SS metric DIN tube fittings
- SS double & single ferrule compression tube fittings
- SS high pressure ball valves
- SS braided PTFE hose assembly
- Hydraulic hose assembly
- Material includes: AISI 304(1.4301), AISI 316L(1.4404), AISI 316Ti(1.4571)

Tube and hose fittings for heavy-duty industrial applications. Our customers trust the quality of QC Hydraulics products – and have for decades. Our fields of application:

- Chemical plants
- Hydraulic engineering and shipbuilding
- Railway technology
- Offshore technology
- Foundry and rolling mill technology
- Machine construction



过渡接头 ADAPTER 公制 DIN 卡套式 METRIC Thread Bite Type Tube Fitting

Q1C,Q1D Q1C/RN,Q1D/RN

直通接头 Straight Fitting

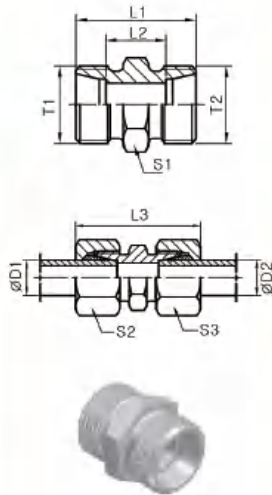

代号 PART NO.	螺纹 THREAD		管子外径 D1/D2	尺寸 DIMENSIONS					重量 克/件	工作压力 (bar)	系列
	T1	T2		L1	L2	L3	S1	S2/S3			
Q1C-12	M12x1.5	M12x1.5	06	24	10	39	12	14	12	500	L
Q1C-14	M14x1.5	M14x1.5	08	25	11	40	14	17	16	500	
Q1C-16	M16x1.5	M16x1.5	10	27	13	42	17	19	23	500	
Q1C-18	M18x1.5	M18x1.5	12	28	14	43	19	22	28	400	
Q1C-22	M22x1.5	M22x1.5	15	30	16	46	24	27	51	400	
Q1C-26	M26x1.5	M26x1.5	18	31	16	48	27	32	69	400	
Q1C-30	M30x2	M30x2	22	35	20	52	32	36	90	250	
Q1C-36	M36x2	M36x2	28	36	21	54	41	41	137	250	
Q1C-45	M45x2	M45x2	35	41	20	63	46	50	214	250	
Q1C-52	M52x2	M52x2	42	43	21	66	55	60	296	250	
Q1D-14	M14x1.5	M14x1.5	06	30	16	45	14	17	26	800	S
Q1D-16	M16x1.5	M16x1.5	08	32	18	47	17	19	37	800	
Q1D-18	M18x1.5	M18x1.5	10	32	17	49	19	22	44	800	
Q1D-20	M20x1.5	M20x1.5	12	34	19	51	22	24	60	630	
Q1D-22	M22x1.5	M22x1.5	14	38	22	57	24	27	77	630	
Q1D-24	M24x1.5	M24x1.5	16	38	21	57	27	30	90	630	
Q1D-30	M30x2	M30x2	20	44	23	66	32	36	143	420	
Q1D-36	M36x2	M36x2	25	50	26	74	41	46	251	420	
Q1D-42	M42x2	M42x2	30	54	27	80	46	50	330	420	
Q1D-52	M52x2	M52x2	38	61	29	90	55	60	545	420	

注：如需带卡套及卡套螺母整套订货，则请在代号后加“RN”，如 Q1C-30/RN。

Note: In case if you are interested to order the adapter in complete set with cutting ring and nut, it is necessary to insert suffix "RN" after our part No., for example Q1C-30/RN.

Q1C9,Q1D9 Q1C9/RN,Q1D9/RN

90°弯接头 90°Elbow Fitting

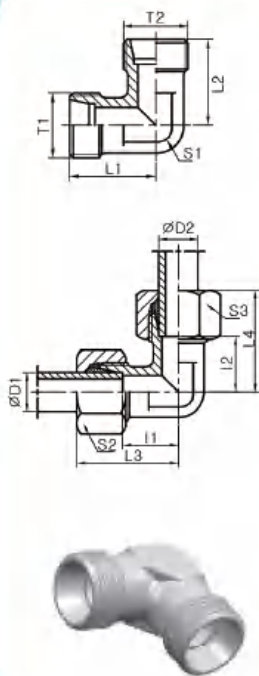

代号 PART NO.	螺纹 THREAD		管子外径 D1/D2	尺寸 DIMENSIONS					重量 克/件	工作压力 (bar)	系列
	T1	T2		L1/L2	L3/L4	I1/I2	S1	S2/S3			
Q1C9-12	M12x1.5	M12x1.5	06	19	27	12	12	14	29	500	L
Q1C9-14	M14x1.5	M14x1.5	08	21	29	14	12	17	43	500	
Q1C9-16	M16x1.5	M16x1.5	10	22	30	15	14	19	54	500	
Q1C9-18	M18x1.5	M18x1.5	12	24	32	17	17	22	80	400	
Q1C9-22	M22x1.5	M22x1.5	15	28	36	21	19	27	81	400	
Q1C9-26	M26x1.5	M26x1.5	18	31	40	23.5	24	32	140	400	
Q1C9-30	M30x2	M30x2	22	35	44	27.5	27	36	178	250	
Q1C9-36	M36x2	M36x2	28	38	47	30.5	36	41	340	250	
Q1C9-45	M45x2	M45x2	35	45	56	34.5	41	50	458	250	
Q1C9-52	M52x2	M52x2	42	51	63	40	50	60	776	250	
Q1D9-14	M14x1.5	M14x1.5	06	23	31	16	12	17	52	800	S
Q1D9-16	M16x1.5	M16x1.5	08	24	32	17	14	19	74	800	
Q1D9-18	M18x1.5	M18x1.5	10	25	34	17.5	17	22	97	800	
Q1D9-20	M20x1.5	M20x1.5	12	29	38	21.5	17	24	137	630	
Q1D9-22	M22x1.5	M22x1.5	14	30	40	22	19	27	145	630	
Q1D9-24	M24x1.5	M24x1.5	16	33	43	24.5	24	30	162	630	
Q1D9-30	M30x2	M30x2	20	37	48	26.5	27	36	221	420	
Q1D9-36	M36x2	M36x2	25	42	54	30	36	46	424	420	
Q1D9-42	M42x2	M42x2	30	49	62	35.5	41	50	603	420	
Q1D9-52	M52x2	M52x2	38	57	72	41	50	60	1010	420	

注：如需带卡套及卡套螺母整套订货，则请在代号后加“RN”，如 Q1C9-30/RN。

Note: In case if you are interested to order the adapter in complete set with cutting ring and nut, it is necessary to insert suffix "RN" after our part No., for example Q1C9-30/RN.

过渡接头 ADAPTER 公制 DIN 卡套式 METRIC Thread Bite Type Tube Fitting

Q1C-Y, Q1D-Y Q1C-Y/RN, Q1D-Y/RN

圆柱过板接头 Cylinder Straight Bulkhead

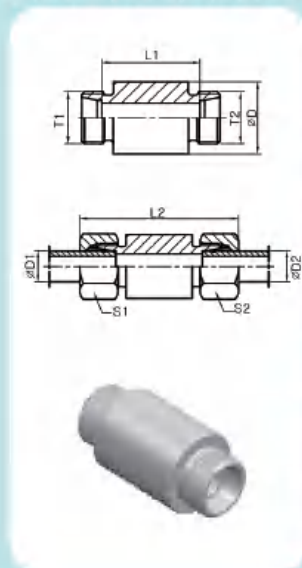

代号 PART NO.	螺纹 THREAD		管子外径		尺寸 DIMENSIONS					重量 克/件	工作压力 (bar)	系列
	T1	T2	D1	D2	D	L1	L2	S1	S2			
Q1C-12Y	M12x1.5	M12x1.5	06	06	18	56	85	14	14	103	500	L
Q1C-14Y	M14x1.5	M14x1.5	08	08	20	56	85	17	17	121	500	
Q1C-16Y	M16x1.5	M16x1.5	10	10	22	58	87	19	19	142	500	
Q1C-18Y	M18x1.5	M18x1.5	12	12	25	58	87	22	22	176	400	
Q1C-22Y	M22x1.5	M22x1.5	15	15	28	70	100	27	27	262	400	
Q1C-26Y	M26x1.5	M26x1.5	18	18	32	69	101	32	32	333	400	
Q1C-30Y	M30x2	M30x2	22	22	36	73	105	36	36	394	250	
Q1C-36Y	M36x2	M36x2	28	28	40	73	106	41	41	448	250	
Q1C-45Y	M45x2	M45x2	35	35	50	71	114	50	50	713	250	
Q1C-52Y	M52x2	M52x2	42	42	60	70	115	60	60	997	250	
Q1D-14Y	M14x1.5	M14x1.5	06	06	20	60	89	17	17	135	800	S
Q1D-16Y	M16x1.5	M16x1.5	08	08	22	60	89	19	19	163	800	
Q1D-18Y	M18x1.5	M18x1.5	10	10	25	59	91	22	22	201	800	
Q1D-20Y	M20x1.5	M20x1.5	12	12	28	59	91	24	24	249	630	
Q1D-22Y	M22x1.5	M22x1.5	14	14	30	72	107	27	27	337	630	
Q1D-24Y	M24x1.5	M24x1.5	16	16	35	71	107	30	30	441	630	
Q1D-30Y	M30x2	M30x2	20	20	38	71	114	36	36	509	420	
Q1D-36Y	M36x2	M36x2	25	25	45	72	120	46	46	720	420	
Q1D-42Y	M42x2	M42x2	30	30	50	73	126	50	50	873	420	
Q1D-52Y	M52x2	M52x2	38	38	60	72	133	60	60	1248	420	

注：如需带卡套及卡套螺母整套订货，则请在代号后加“RN”，如 Q1C-30Y/RN
 Note: In case if you are interested to order the adapter in complete set with cutting ring and nut, it is necessary to insert suffix "RN" after our part No., for example Q1C-30Y/RN

QAC,QAD QAC/RN,QAD/RN

三通接头 Equal Tees

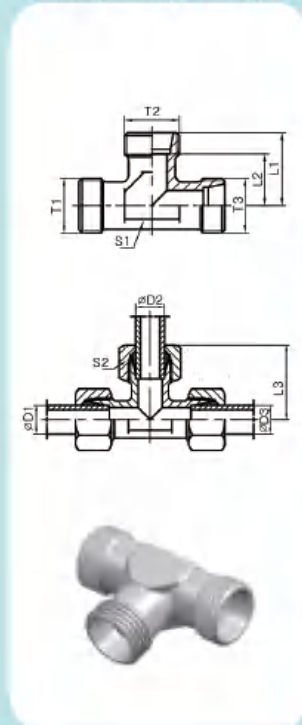

代号 PART NO.	螺纹 THREAD T1/T2/T3	管子外径 D1/D2/D3	尺寸 DIMENSIONS					重量 克/件	工作压力 (bar)	系列
			L1	L2	L3	S1	S2			
QAC-12	M12x1.5	06	19	12	27	12	14	37	500	L
QAC-14	M14x1.5	08	21	14	29	12	17	53	500	
QAC-16	M16x1.5	10	22	15	30	14	19	48	500	
QAC-18	M18x1.5	12	24	17	32	17	22	65	400	
QAC-22	M22x1.5	15	28	21	36	19	27	106	400	
QAC-26	M26x1.5	18	31	23.5	40	24	32	179	400	
QAC-30	M30x2	22	35	27.5	44	27	36	225	250	
QAC-36	M36x2	28	38	30.5	47	36	41	396	250	
QAC-45	M45x2	35	45	34.5	56	41	50	567	250	
QAC-52	M52x2	42	51	40	63	50	60	905	250	
QAD-14	M14x1.5	06	23	16	31	12	17	68	800	S
QAD-16	M16x1.5	08	24	17	32	14	19	70	800	
QAD-18	M18x1.5	10	25	17.5	34	17	22	91	800	
QAD-20	M20x1.5	12	29	21.5	38	17	24	117	630	
QAD-22	M22x1.5	14	30	22	40	19	27	136	620	
QAD-24	M24x1.5	16	33	24.5	43	24	30	202	630	
QAD-30	M30x2	20	37	26.5	48	27	36	289	420	
QAD-36	M36x2	25	42	30	54	36	46	545	420	
QAD-42	M42x2	30	49	35.5	62	41	50	758	420	
QAD-52	M52x2	38	57	41	72	50	60	1264	420	

注：如需带卡套及卡套螺母整套订货，则请在代号后加“RN”，如 QAC-30/RN。
 Note: In case if you are interested to order the adapter in complete set with cutting ring and nut, it is necessary to insert suffix "RN" after our part No., for example QAC-30/RN.

过渡接头 ADAPTER 公制 DIN 卡套式 METRIC Thread Bite Type Tube Fitting

QXC, QXD QXC/RN, QXD/RN

四通接头 Cross Fittings

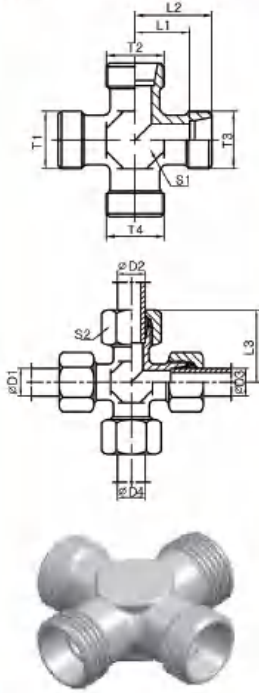

代号 PART NO.	螺纹 THREAD		管子外径		尺寸 DIMENSIONS								重量 克/件	工作压力 (bar)	系列
	T1/T2/T3/T4	D1/D2/D3/D4	L1	L2	L3	S1	S2								
QXC-12	M12x1.5	06	19	12	27	12	14						35	315	L
QXC-14	M14x1.5	08	21	14	29	12	17						40	315	
QXC-16	M16x1.5	10	22	15	30	14	19						52	315	
QXC-18	M18x1.5	12	24	17	32	17	22						69	315	
QXC-22	M22x1.5	15	28	21	36	19	27						130	315	
QXC-26	M26x1.5	18	31	23.5	40	24	32						188	315	
QXC-30	M30x2	22	35	27.5	44	27	36						251	160	
QXC-36	M36x2	28	38	30.5	47	36	41						392	160	
QXC-45	M45x2	35	45	34.5	56	41	50						618	160	
QXC-52	M52x2	42	51	40	63	50	60						905	160	
QXD-14	M14x1.5	06	23	16	31	12	17						58	630	S
QXD-16	M16x1.5	08	24	17	32	14	19						82	630	
QXD-18	M18x1.5	10	25	17.5	34	17	22						97	630	
QXD-20	M20x1.5	12	29	21.5	38	17	24						146	630	
QXD-22	M22x1.5	14	30	22	40	19	27						176	400	
QXD-24	M24x1.5	16	33	24.5	43	24	30						220	400	
QXD-30	M30x2	20	37	26.5	48	27	36						339	315	
QXD-36	M36x2	25	42	30	54	36	46						576	315	
QXD-42	M42x2	30	49	35.5	62	41	50						843	315	
QXD-52	M52x2	38	57	41	72	50	60						1350	315	

注：如需带卡套及卡套螺母整套订货，则请在代号后加“RN”，如 QXC-30/RN
 Note: In case if you are interested to order the adapter in complete set with cutting ring and nut, it is necessary to insert suffix "RN" after our part No., for example QXC-30/RN

Q6C-LN, Q6D-LN Q6C-LN/RN, Q6D-LN/RN

直通过板接头 Straight Bulkhead Fittings

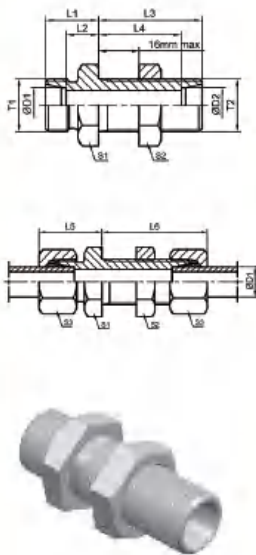

代号 PART NO.	螺纹 THREAD		管子外径		尺寸 DIMENSIONS										重量 克/件	工作压力 (bar)	系列
	T1	T2	D1	D2	L1	L2	L3	L4	L5	L6	S1	S2	S3/S4				
Q6C-12LN	M12x1.5	M12x1.5	06	06	14	7	34	27	22	42	17	17	14	39	500	L	
Q6C-14LN	M14x1.5	M14x1.5	08	08	15	8	34	27	23	42	19	19	17	50	500		
Q6C-16LN	M16x1.5	M16x1.5	10	10	17	10	35	28	25	43	22	22	19	67	500		
Q6C-18LN	M18x1.5	M18x1.5	12	12	17	10	36	29	25	44	24	24	22	78	400		
Q6C-22LN	M22x1.5	M22x1.5	15	15	19	12	38	31	27	46	27	30	27	128	400		
Q6C-26LN	M26x1.5	M26x1.5	18	18	21	13.5	40	32.5	30	49	32	36	32	198	400		
Q6C-30LN	M30x2	M30x2	22	22	24	16.5	42	34.5	33	51	36	41	36	254	250		
Q6C-36LN	M36x2	M36x2	28	28	26	18.5	43	35.5	35	52	41	46	41	335	250		
Q6C-45LN	M45x2	M45x2	35	35	29	18.5	47	36.5	40	58	50	55	50	546	250		
Q6C-52LN	M52x2	M52x2	42	42	30	19	47	36	42	59	60	65	60	758	250		
Q6D-14LN	M14x1.5	M14x1.5	06	06	19	12	36	29	27	44	19	19	17	65	900	S	
Q6D-16LN	M16x1.5	M16x1.5	08	08	20	13	36	29	28	44	22	22	19	87	900		
Q6D-18LN	M18x1.5	M18x1.5	10	10	22	14.5	37	29.5	31	46	24	24	22	112	900		
Q6D-20LN	M20x1.5	M20x1.5	12	12	22	14.5	38	30.5	31	47	27	27	24	141	900		
Q6D-22LN	M22x1.5	M22x1.5	14	14	25	17	40	32	35	50	30	30	27	180	700		
Q6D-24LN	M24x1.5	M24x1.5	16	16	25	16.5	40	31.5	35	50	32	32	30	201	630		
Q6D-30LN	M30x2	M30x2	20	20	28	17.5	44	33.5	39	55	41	41	36	462	630		
Q6D-36LN	M36x2	M36x2	25	25	32	20	47	35	44	59	46	46	46	492	630		
Q6D-42LN	M42x2	M42x2	30	30	35	21.5	51	37.5	48	64	50	50	50	631	420		
Q6D-52LN	M52x2	M52x2	38	38	38	22	53	37	53	68	65	65	60	1083	420		

注：如需带卡套及卡套螺母整套订货，则请在代号后加“RN”，如 Q6C-30LN/RN；
 Note: In case if you are interested to order the adapter in complete set with cutting ring and nut, it is necessary to insert suffix "RN" after our part No., for example Q6C-30LN/RN;

过渡接头 ADAPTER 公制 DIN 卡套式 METRIC Thread Bite Type Tube Fitting

Q6C9-LN.Q6D9-LN

Q6C9-LN/RN.Q6D9-LN/RN

90°弯过板接头 90° Elbow Bulkhead Fittings

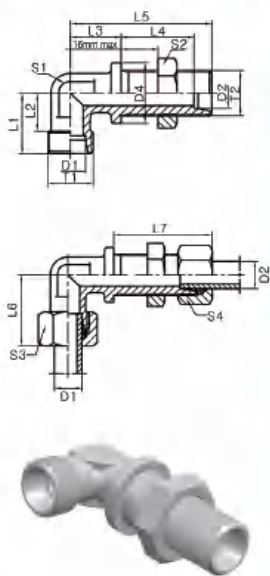

代号 PART NO.	螺纹 THREAD		管子外径			尺寸 DIMENSIONS										重量 克/件	工作压力 (bar)	系列
	T1	T2	D1	D2	D4	L1	L2	L3	L4	L5	L6	L7	S1	S2	S3/S4			
Q6C9-12LN	M12x1.5	M12x1.5	06	06	17	19	12	14	27	48	27	42	12	17	14	51	315	L
Q6C9-14LN	M14x1.5	M14x1.5	08	08	19	21	14	17	27	51	29	42	12	19	17	61	315	
Q6C9-16LN	M16x1.5	M16x1.5	10	10	22	22	15	18	28	53	30	43	14	22	19	78	315	
Q6C9-18LN	M18x1.5	M18x1.5	12	12	24	24	17	20	29	56	32	44	17	24	22	85	315	
Q6C9-22LN	M22x1.5	M22x1.5	15	15	27	28	21	23	31	61	36	46	19	30	27	150	315	
Q6C9-26LN	M26x1.5	M26x1.5	18	18	32	31	23.5	24	32.5	64	40	49	24	36	32	238	315	
Q6C9-30LN	M30x2	M30x2	22	22	36	35	27.5	30	34.5	72	44	51	27	41	36	327	160	
Q6C9-36LN	M36x2	M36x2	28	28	42	38	30.5	34	35.5	77	47	52	36	46	41	482	160	
Q6C9-45LN	M45x2	M45x2	35	35	50	45	34.5	39	36.5	86	56	58	41	55	50	729	160	
Q6C9-52LN	M52x2	M52x2	42	42	60	51	40	43	36	90	63	59	50	65	60	1091	160	
Q6D9-14LN	M14x1.5	M14x1.5	06	06	19	23	16	17	29	53	31	44	12	19	17	72	630	S
Q6D9-16LN	M16x1.5	M16x1.5	08	08	22	24	17	18	29	54	32	44	14	22	19	99	630	
Q6D9-18LN	M18x1.5	M18x1.5	10	10	24	25	17.5	20	29.5	57	34	46	17	24	22	128	630	
Q6D9-20LN	M20x1.5	M20x1.5	12	12	27	29	21.5	21	30.5	59	38	47	17	27	24	168	630	
Q6D9-22LN	M22x1.5	M22x1.5	14	14	27	30	22	23	32	63	40	50	19	30	27	194	630	
Q6D9-24LN	M24x1.5	M24x1.5	16	16	30	33	24.5	24	31.5	64	43	50	24	32	30	249	400	
Q6D9-30LN	M30x2	M30x2	20	20	36	37	26.5	30	33.5	74	48	55	27	41	36	390	400	
Q6D9-36LN	M36x2	M36x2	25	25	42	42	30	34	35	81	54	59	36	46	46	618	400	
Q6D9-42LN	M42x2	M42x2	30	30	50	49	35.5	39	37.5	90	62	64	41	50	50	889	500	
Q6D9-52LN	M52x2	M52x2	38	38	60	57	41	43	37	96	72	68	50	65	60	1337	315	

注：如需带卡套及卡套螺母整套订货，则请在代号后加“RN”，如 Q6C9-30LN/RN；
 Note: In case if you are interested to order the adapter in complete set with cutting ring and nut, it is necessary to insert suffix "RN" after our part No., for example Q6C9-30LN/RN;

Q2C-W.Q2D-W

Q2C-W/RN.Q2D-W/RN

外螺纹内螺纹转换接头 Reducer Tube Adaptor With Swivel Nut

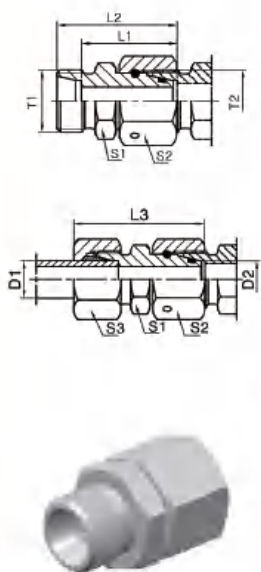

代号 PART NO.	螺纹 THREAD		管子外径 D1/D2	尺寸 DIMENSIONS					重量 克/件	工作压力 (bar)	系列
	T1	T2		L1	L2	L3	S1	S2/S3			
Q2C-12W	M12x1.5	M12x1.5	06	36	43	51	12	14	33	500	L
Q2C-14W	M14x1.5	M14x1.5	08	36	43	51	14	17	46	500	
Q2C-16W	M16x1.5	M16x1.5	10	36	43	51	17	19	60	500	
Q2C-18W	M18x1.5	M18x1.5	12	36	43	51	19	22	75	400	
Q2C-22W	M22x1.5	M22x1.5	15	36	43	51	24	27	118	400	
Q2C-26W	M26x1.5	M26x1.5	18	36	43.5	52	27	32	153	400	
Q2C-30W	M30x2	M30x2	22	40	47.5	56	32	36	210	250	
Q2C-36W	M36x2	M36x2	28	40	47.5	57	41	41	279	250	
Q2C-45W	M45x2	M45x2	35	50	60.5	72	46	50	468	250	
Q2C-52W	M52x2	M52x2	42	60	71	83	55	60	802	250	
Q2D-14W	M14x1.5	M14x1.5	06	36	43	51	14	17	48	800	S
Q2D-16W	M16x1.5	M16x1.5	08	36	43	51	17	19	64	800	
Q2D-18W	M18x1.5	M18x1.5	10	36	43.5	52	19	22	81	800	
Q2D-20W	M20x1.5	M20x1.5	12	36	43.5	52	22	24	97	630	
Q2D-22W	M22x1.5	M22x1.5	14	40	48	58	24	27	133	630	
Q2D-24W	M24x1.5	M24x1.5	16	40	48.5	58	27	30	166	630	
Q2D-30W	M30x2	M30x2	20	46	56.5	68	32	36	265	420	
Q2D-36W	M36x2	M36x2	25	50	62	74	41	46	466	420	
Q2D-42W	M42x2	M42x2	30	56	69.5	83	46	50	601	420	
Q2D-52W	M52x2	M52x2	38	60	76	91	55	60	871	420	

注：如需带卡套及卡套螺母整套订货，则请在代号后加“RN”，如 Q2C-30/RN
 Note: In case if you are interested to order the adapter in complete set with cutting ring and nut, it is necessary to insert suffix "RN" after our part No., for example Q2C-30/RN

过渡接头 ADAPTER 公制 DIN 卡套式 METRIC Thread Bite Type Tube Fitting

Q2C4-W, Q2D4-W

Q2C4-W/RN, Q2D4-W/RN

45°弯外螺纹内螺纹转换接头
45° Elbow Reducer Tube Adaptor With Swivel Nut

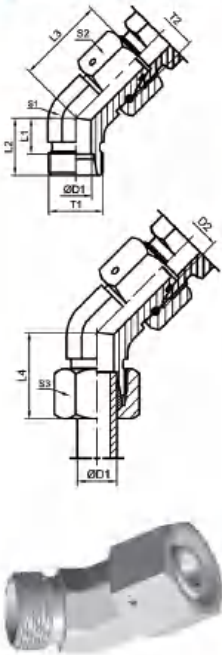

代号 PART NO.	螺纹 THREAD		管子外径 TUBE O.D		尺寸 DIMENSIONS						重量 克/件	工作压力 (bar)	系列
	T1	T2	D1	D2	L1	L2	L3	S1	S2/S3				
Q2C4-12W	M12x1.5	M12x1.5	06	9	16	26	24	14	14	37	500	L	
Q2C4-14W	M14x1.5	M14x1.5	08	12	19	27.5	27	14	17	49	500		
Q2C4-16W	M16x1.5	M16x1.5	10	12	19	29	27	19	19	77	500		
Q2C4-18W	M18x1.5	M18x1.5	12	14	21	29.5	29	19	22	86	400		
Q2C4-22W	M22x1.5	M22x1.5	15	17	24	32.5	32	22	27	144	400		
Q2C4-26W	M26x1.5	M26x1.5	18	16.5	24	35.5	33	27	32	210	400		
Q2C4-30W	M30x2	M30x2	22	18.5	26	38.5	35	30	36	270	250		
Q2C4-36W	M36x2	M36x2	28	23	30.5	41.5	40	36	41	385	250		
Q2C4-45W	M45x2	M45x2	35	26.5	37	51	48	50	50	805	250		
Q2C4-52W	M52x2	M52x2	42	26	37	56	49	50	60	887	250		
Q2D4-14W	M14x1.5	M14x1.5	06	9	16	27	24	14	17	50	800	S	
Q2D4-16W	M16x1.5	M16x1.5	08	12	19	27.5	27	19	19	80	800		
Q2D4-18W	M18x1.5	M18x1.5	10	13.5	21	30	30	19	22	95	800		
Q2D4-20W	M20x1.5	M20x1.5	12	16.5	24	31	33	22	24	137	630		
Q2D4-24W	M24x1.5	M24x1.5	16	15.5	24	36.5	34	27	30	217	630		
Q2D4-30W	M30x2	M30x2	20	16	26.5	44.5	38	30	36	313	420		
Q2D4-36W	M36x2	M36x2	25	18.5	30.5	50	43	36	46	529	420		
Q2D4-42W	M42x2	M42x2	30	23.5	37	55	50	50	50	940	420		
Q2D4-52W	M52x2	M52x2	38	21	37	63	52	50	60	1055	420		

注：如需带卡套及卡套螺母整套订货，则请在代号后加“RN”，如 Q2C4-30W/RN

Note: In case if you are interested to order the adapter in complete set with cutting ring and nut, it is necessary to insert suffix "RN" after our part No., for example Q2C4-30W/RN

Q2C9-W, Q2D9-W

Q2C9-W/RN, Q2D9-W/RN

90°弯外螺纹内螺纹转换接头
90° Elbow Reducer Tube Adaptor With Swivel Nut

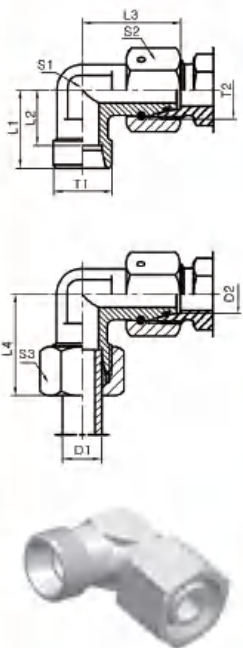

代号 PART NO.	螺纹 THREAD		管子外径		尺寸 DIMENSIONS						重量 克/件	工作压力 (bar)	系列
	T1	T2	D1/D2	L1	L2	L3	L4	S1	S2/S3				
Q2C9-12W	M12x1.5	M12x1.5	06	19	12	26	27	12	14	34	500	L	
Q2C9-14W	M14x1.5	M14x1.5	08	21	14	27.5	29	12	17	43	500		
Q2C9-16W	M16x1.5	M16x1.5	10	22	15	29	30	14	19	58	500		
Q2C9-18W	M18x1.5	M18x1.5	12	24	17	29.5	32	17	22	81	400		
Q2C9-22W	M22x1.5	M22x1.5	15	28	21	32.5	36	19	27	128	400		
Q2C9-26W	M26x1.5	M26x1.5	18	31	23.5	35.5	40	24	32	197	400		
Q2C9-30W	M30x2	M30x2	22	35	27.5	38.5	44	27	36	258	250		
Q2C9-36W	M36x2	M36x2	28	38	30.5	41.5	47	36	41	370	250		
Q2C9-45W	M45x2	M45x2	35	45	34.5	51	56	41	50	593	250		
Q2C9-52W	M52x2	M52x2	42	51	40	56	63	50	60	993	250		
Q2D9-14W	M14x1.5	M14x1.5	06	23	16	27	31	12	17	48	800	S	
Q2D9-16W	M16x1.5	M16x1.5	08	24	17	27.5	32	14	19	65	800		
Q2D9-18W	M18x1.5	M18x1.5	10	25	17.5	30	34	17	22	92	800		
Q2D9-20W	M20x1.5	M20x1.5	12	29	21.5	31	38	17	24	107	630		
Q2D9-22W	M22x1.5	M22x1.5	14	30	22	35	40	19	27	146	630		
Q2D9-24W	M24x1.5	M24x1.5	16	33	24.5	36.5	43	24	30	212	630		
Q2D9-30W	M30x2	M30x2	20	37	26.5	44.5	48	27	36	309	420		
Q2D9-36W	M36x2	M36x2	25	42	30	50	54	36	46	547	420		
Q2D9-42W	M42x2	M42x2	30	49	35.5	55	62	41	50	744	420		
Q2D9-52W	M52x2	M52x2	38	57	41	63	72	50	60	1222	420		

注：如需带卡套及卡套螺母整套订货，则请在代号后加“RN”，如 Q2C9-30W/RN

Note: In case if you are interested to order the adapter in complete set with cutting ring and nut, it is necessary to insert suffix "RN" after our part No., for example Q2C9-30W/RN

Q3C-W Q3D-W

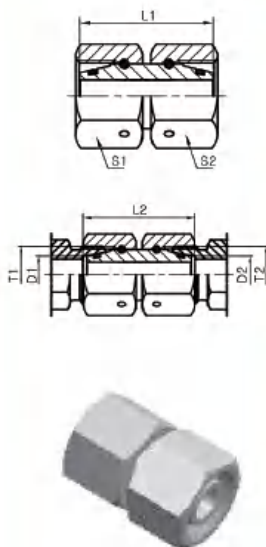

内螺纹直接接头 Straight Tube Adaptor With Swivel Nut

代号 PART NO.	螺纹 THREAD		管子外径 D1/D2	尺寸 DIMENSIONS				重量 克/件	工作压力 (bar)	系列
	T1	T2		L1	L2	S1/S2				
Q3C-12W	M12x1.5	M12x1.5	06	32	33	14		28	500	L
Q3C-14W	M14x1.5	M14x1.5	08	32	33	17		41	500	
Q3C-16W	M16x1.5	M16x1.5	10	33	34	19		53	500	
Q3C-18W	M18x1.5	M18x1.5	12	33	34	22		71	400	
Q3C-22W	M22x1.5	M22x1.5	15	38	39	27		129	400	
Q3C-26W	M26x1.5	M26x1.5	18	38	40	32		165	400	
Q3C-30W	M30x2	M30x2	22	42	44	36		243	250	
Q3C-36W	M36x2	M36x2	28	46	48	41		319	250	
Q3C-45W	M45x2	M45x2	35	48	52	50		449	250	
Q3C-52W	M52x2	M52x2	42	52	57	60		737	250	
Q3D-14W	M14x1.5	M14x1.5	06	32	33	17		41	800	S
Q3D-16W	M16x1.5	M16x1.5	08	33	34	19		54	800	
Q3D-18W	M18x1.5	M18x1.5	10	33	35	22		74	800	
Q3D-20W	M20x1.5	M20x1.5	12	36	38	24		95	630	
Q3D-22W	M22x1.5	M22x1.5	14	39	41	27		131	630	
Q3D-24W	M24x1.5	M24x1.5	16	39	42	30		172	630	
Q3D-30W	M30x2	M30x2	20	44	48	36		261	420	
Q3D-36W	M36x2	M36x2	25	46	53	46		477	420	
Q3D-42W	M42x2	M42x2	30	52	62	50		605	420	
Q3D-52W	M52x2	M52x2	38	52	67	60		826	420	

QBC-W, QBD-W QBC-W/RN QBD-W/RN

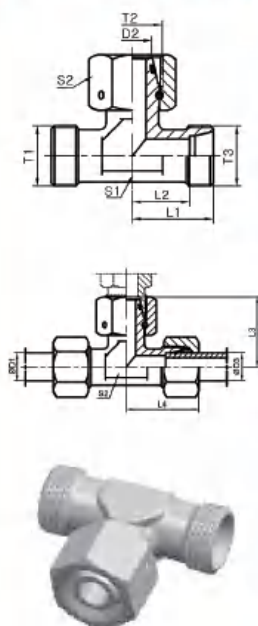

中间端内螺纹组合三通接头 Branch Tee Fittings With Swivel Nut

代号 PART NO.	螺纹 THREAD T1/T3/T2	管子外径		尺寸 DIMENSIONS						重量 克/件	工作压力 (bar)	系列
		D1/D3	D2	L1	L2	L3	L4	S1	S2			
QBC-12W	M12x1.5	06	06	19	12	26	27	12	14	42	500	L
QBC-14W	M14x1.5	08	08	21	14	27.5	29	12	17	53	500	
QBC-16W	M16x1.5	10	10	22	15	29	30	14	19	71	500	
QBC-18W	M18x1.5	12	12	24	17	29.5	32	17	22	97	400	
QBC-22W	M22x1.5	15	15	28	21	32.5	36	19	27	159	400	
QBC-26W	M26x1.5	18	18	31	23.5	35.5	40	24	32	239	400	
QBC-30W	M30x2	22	22	35	27.5	38.5	44	27	36	308	250	
QBC-36W	M36x2	28	28	38	30.5	41.5	47	36	41	449	250	
QBC-45W	M45x2	35	35	45	34.5	51	56	41	50	679	250	
QBC-52W	M52x2	42	42	51	40	56	63	50	60	1131	250	
QBD-14W	M14x1.5	06	06	23	16	27	31	12	17	63	800	S
QBD-16W	M16x1.5	08	08	24	17	27.5	32	14	19	79	800	
QBD-18W	M18x1.5	10	10	25	17.5	30	34	17	22	113	800	
QBD-20W	M20x1.5	12	12	29	21.5	31	38	17	24	136	630	
QBD-22W	M22x1.5	14	14	30	22	35	40	19	27	173	630	
QBD-24W	M24x1.5	16	16	33	24.5	36.5	43	24	30	239	630	
QBD-30W	M30x2	20	20	37	26.5	44.5	48	27	36	388	420	
QBD-36W	M36x2	25	25	42	30	50	54	36	46	652	420	
QBD-42W	M42x2	30	30	49	35.5	55	62	41	50	905	420	
QBD-52W	M52x2	38	38	57	41	60	72	50	60	1462	420	

注：如需带卡套及卡套螺母整套订货，则请在代号后加“RN”，如QBC-30W/RN

Note: In case if you are interested to order the adapter in complete set with cutting ring and nut, it is necessary to insert suffix "RN" after our part No., for example QBC-30W/RN

过渡接头 ADAPTER 公制 DIN 卡套式 METRIC Thread Bite Type Tube Fitting

QCC-W, QCD-W
QCC-W/RN, QCD-W/RN

内螺纹主支三通接头
Run Tee Fittings With Swivel Nut

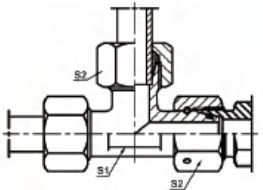
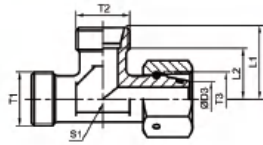

代号 PART NO.	螺纹 THREAD		管子外径		尺寸 DIMENSIONS						重量 克/件	工作压力 (bar)	系列
	T1/T2	T3	D1/D2	D3	L1	L2	L3	L4	S1	S2			
QCC-12W	M12x1.5	M12x1.5	06	06	19	12	26	27	12	14	42	500	L
QCC-14W	M14x1.5	M14x1.5	08	08	21	14	27.5	29	12	17	53	500	
QCC-16W	M16x1.5	M16x1.5	10	10	22	15	29	30	14	19	71	500	
QCC-18W	M18x1.5	M18x1.5	12	12	24	17	29.5	32	17	22	97	400	
QCC-22W	M22x1.5	M22x1.5	15	15	28	21	32.5	36	19	27	159	400	
QCC-26W	M26x1.5	M26x1.5	18	18	31	23.5	35.5	40	24	32	239	400	
QCC-30W	M30x2	M30x2	22	22	35	27.5	38.5	44	27	36	308	250	
QCC-36W	M36x2	M36x2	28	28	38	30.5	41.5	47	36	41	449	250	
QCC-45W	M45x2	M45x2	35	35	45	34.5	51	56	41	50	679	250	
QCC-52W	M52x2	M52x2	42	42	51	40	56	63	50	60	1131	250	
QCD-14W	M14x1.5	M14x1.5	06	06	23	16	27	31	12	17	63	800	S
QCD-16W	M16x1.5	M16x1.5	08	08	24	17	27.5	32	14	19	79	800	
QCD-18W	M18x1.5	M18x1.5	10	10	25	17.5	30	34	17	22	113	800	
QCD-20W	M20x1.5	M20x1.5	12	12	29	21.5	31	38	17	24	136	630	
QCD-22W	M22x1.5	M22x1.5	14	14	30	22	35	40	19	27	173	630	
QCD-24W	M24x1.5	M24x1.5	16	16	33	24.5	36.5	43	24	30	239	630	
QCD-30W	M30x2	M30x2	20	20	37	26.5	44.5	48	27	36	388	420	
QCD-36W	M36x2	M36x2	25	25	42	30	50	54	36	46	652	420	
QCD-42W	M42x2	M42x2	30	30	49	35.5	55	62	41	50	905	420	
QCD-52W	M52x2	M52x2	38	38	57	41	60	72	50	60	1462	420	

注：如需带卡套及卡套螺母整套订货，则请在代号后加“RN”，如QCC-30W/RN

Note: In case if you are interested to order the adapter in complete set with cutting ring and nut, it is necessary to insert suffix "RN" after our part No., for example QCC-30W/RN

过渡接头 ADAPTER

公制 DIN 卡套式 METRIC Thread Bite Type Tube Fitting

Q1CB, Q1DB Q1CB/RN, Q1DB/RN

英管螺纹60°密封或组合垫密封两用柱端
BSP Thread 60° Cone Sealing

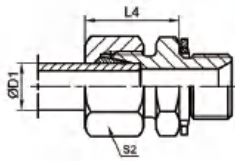
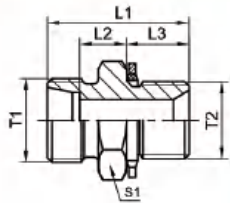

代号 PART NO.	螺纹 THREAD		管子外径 D1	尺寸 DIMENSIONS						重量 克/件	工作压力 (bar)	系列
	T1	T2		L1	L2	L3	L4	S1	S2			
Q1CB-12-02	M12x1.5	G1/8"X28	06	25	10	8	23	14	14	12	500	L
Q1CB-12-04	M12x1.5	G1/4"X19	06	28	12	11	24	19	14	28	500	
Q1CB-14-02	M14x1.5	G1/8"X28	08	25	10	8	23	14	17	16	500	
Q1CB-14-04	M14x1.5	G1/4"X19	08	28	12	11	24	19	17	27	500	
Q1CB-14-06	M14x1.5	G3/8"X19	08	29.5	13.5	12	24	22	17	44	420	
Q1CB-16-04	M16x1.5	G1/4"X19	10	29	12	11	25	19	19	29	500	
Q1CB-16-06	M16x1.5	G3/8"X19	10	30.5	13.5	12	25	22	19	42	420	
Q1CB-16-08	M16x1.5	G1/2"X14	10	34	16	14	26	27	19	70	400	
Q1CB-18-04	M18x1.5	G1/4"X19	12	29	12	11	25	19	22	30	400	
Q1CB-18-06	M18x1.5	G3/8"X19	12	30.5	13.5	12	25	22	22	40	420	
Q1CB-18-08	M18x1.5	G1/2"X14	12	34	16	14	26	27	22	66	400	
Q1CB-18-12	M18x1.5	G3/4"X14	12	36.5	18.5	16	26	32	22	117	250	
Q1CB-22-06	M22x1.5	G3/8"X19	15	32	13.5	12	26	24	27	53	400	
Q1CB-22-08	M22x1.5	G1/2"X14	15	35.5	16	14	27	27	27	71	400	
Q1CB-26-08	M26x1.5	G1/2"X14	18	35	16	14	28	27	32	70	400	
Q1CB-26-12	M26x1.5	G3/4"X14	18	37.5	18.5	16	28	32	32	118	250	
Q1CB-30-12	M30x2	G3/4"X14	22	39.5	18.5	16	30	32	36	101	250	
Q1CB-36-16	M36x2	G1"X11	28	42.5	20.5	19	31	41	41	168	250	
Q1CB-45-20	M45x2	G1.1/4"X11	35	46.5	20.5	20	37	50	50	270	250	
Q1CB-52-24	M52x2	G1.1/2"X11	42	50	23	22	39	55	60	340	250	
Q1DB-14-04	M14x1.5	G1/4"X19	06	32	12	11	28	19	17	35	800	
Q1DB-16-04	M16x1.5	G1/4"X19	08	32	12	11	28	19	19	40	800	
Q1DB-16-06	M16x1.5	G3/8"X19	08	35.5	13.5	12	32	22	19	56	800	
Q1DB-18-04	M18x1.5	G1/4"X19	10	32	12	11	29	19	22	41	400	
Q1DB-18-06	M18x1.5	G3/8"X19	10	35.5	13.5	12	31	22	22	54	800	
Q1DB-18-08	M18x1.5	G1/2"X14	10	38	16	14	31	27	22	95	630	
Q1DB-20-04	M20x1.5	G1/4"X19	12	34	12	11	31	22	24	60	630	
Q1DB-20-06	M20x1.5	G3/8"X19	12	35.5	13.5	12	31	22	24	62	630	
Q1DB-20-08	M20x1.5	G1/2"X14	12	38	16	14	31	27	24	98	630	
Q1DB-22-08	M22x1.5	G1/2"X14	14	40	16	14	34	27	27	95	630	
Q1DB-24-06	M24x1.5	G3/8"X19	16	37.5	13.5	12	34	27	30	82	630	
Q1DB-24-08	M24x1.5	G1/2"X14	16	40	16	14	34	27	30	90	630	
Q1DB-24-12	M24x1.5	G3/4"X14	16	44.5	18.5	16	36	32	30	150	420	
Q1DB-30-12	M30x2	G3/4"X14	20	46.5	18.5	16	39	32	36	147	420	
Q1DB-36-08	M36x2	G1/2"X14	25	47	16	14	43	41	46	226	420	
Q1DB-36-12	M36x2	G3/4"X14	25	49.5	18.5	16	43	41	46	264	420	
Q1DB-36-16	M36x2	G1"X11	25	52.5	20.5	19	44	41	46	400	420	
Q1DB-42-20	M42x2	G1.1/4"X11	30	55.5	20.5	20	48	50	50	415	420	
Q1DB-52-24	M52x2	G1.1/2"X11	38	62	23	22	54	55	60	560	420	

注：如需带卡套及卡套螺母整套订货，则请在代号后加“RN”，如Q1CB-30-12/RN

Note: In case if you are interested to order the adapter in complete set with cutting ring and nut, it is necessary to insert suffix "RN" after our part No., for example Q1CB-30-12/RN

过渡接头 ADAPTER 公制 DIN 卡套式 METRIC Thread Bite Type Tube Fitting

Q1CB-WD Q1CB-WD/RN

英管螺纹胶垫密封柱端或60°锥密封
BSP Thread With Captive Seal or 60°Seat Sealing

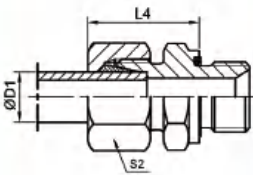
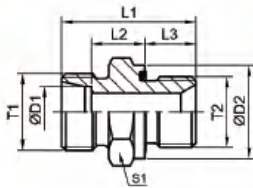

代号 PART NO.	螺纹 THREAD		管子外径		尺寸 DIMENSIONS						重量 克/件	工作压力 (bar)	系列
	T1	T2	D1	D2	L1	L2	L3	L4	S1	S2			
Q1CB-12-02WD	M12x1.5	G1/8"x28	06	14	23.5	8.5	8	23	14	14	13	500	
Q1CB-12-04WD	M12x1.5	G1/4"x19	06	19	29	10	12	25	19	14	28	500	
Q1CB-12-06WD	M12x1.5	G3/8"x19	06	22	30.5	11.5	12	26	22	14	44	420	
Q1CB-12-08WD	M12x1.5	G1/2"x14	06	27	33	12	14	27	27	14	61	400	
Q1CB-14-02WD	M14x1.5	G1/8"x28	08	14	24.5	9.5	8	24	14	17	16	500	
Q1CB-14-04WD	M14x1.5	G1/4"x19	08	19	29	10	12	25	19	17	27	500	
Q1CB-14-06WD	M14x1.5	G3/8"x19	08	22	30.5	11.5	12	26	22	17	45	420	
Q1CB-14-08WD	M14x1.5	G1/2"x14	08	27	33	12	14	27	27	17	74	400	
Q1CB-16-02WD	M16x1.5	G1/8"x28	10	14	25.5	10.5	8	25	17	19	21	500	
Q1CB-16-04WD	M16x1.5	G1/4"x19	10	19	30	11	12	26	19	19	29	500	
Q1CB-16-06WD	M16x1.5	G3/8"x19	10	22	31.5	12.5	12	27	22	19	43	420	
Q1CB-16-08WD	M16x1.5	G1/2"x14	10	27	34	13	14	28	27	19	71	400	
Q1CB-18-02WD	M18x1.5	G1/8"x28	12	14	26.5	11.5	8	26	19	22	26	420	
Q1CB-18-04WD	M18x1.5	G1/4"x19	12	19	31	12	12	27	19	22	31	400	
Q1CB-18-06WD	M18x1.5	G3/8"x19	12	22	31.5	12.5	12	27	22	22	41	420	
Q1CB-18-08WD	M18x1.5	G1/2"x14	12	27	34	13	14	28	27	22	67	400	
Q1CB-18-12WD	M18x1.5	G3/4"x14	12	32	37	14	16	29	32	22	118	250	L
Q1CB-22-06WD	M22x1.5	G3/8"x19	15	22	32.5	13.5	12	29	24	27	54	400	
Q1CB-22-08WD	M22x1.5	G1/2"x14	15	27	35	14	14	29	27	27	72	400	
Q1CB-22-12WD	M22x1.5	G3/4"x14	15	32	38	15	16	30	32	27	116	250	
Q1CB-26-06WD	M26x1.5	G3/8"x19	18	22	33.5	14	12	30	27	32	66	400	
Q1CB-26-08WD	M26x1.5	G1/2"x14	18	27	36	14.5	14	31	27	32	71	400	
Q1CB-26-12WD	M26x1.5	G3/4"x14	18	32	38	14.5	16	31	32	32	110	250	
Q1CB-30-08WD	M18x2	G1/2"x14	22	27	38	16.5	14	33	32	36	91	250	
Q1CB-30-12WD	M18x2	G3/4"x14	22	32	40	16.5	16	33	32	36	102	250	
Q1CB-30-16WD	M30x2	G1"x11	22	40	43	17.5	18	34	41	36	189	250	
Q1CB-36-12WD	M36x2	G3/4"x14	28	32	41	17.5	16	34	41	41	159	250	
Q1CB-36-16WD	M36x2	G1"x11	28	40	43	17.5	18	34	41	41	170	250	
Q1CB-36-20WD	M36x2	G1.1/4"x11	28	50	46	18.5	20	35	50	41	316	250	
Q1CB-45-16WD	M45x2	G1"x11	35	40	46	17.5	18	39	46	50	226	250	
Q1CB-45-20WD	M45x2	G1.1/4"x11	35	50	48	17.5	20	39	50	50	272	250	
Q1CB-45-24WD	M45x2	G1.1/2"x11	35	55	52	19.5	22	41	55	50	423	250	
Q1CB-52-16WD	M52x2	G1"x11	42	40	48	19	18	42	55	60	324	250	
Q1CB-52-20WD	M52x2	G1.1/4"x11	42	50	50	19	20	42	55	60	348	250	
Q1CB-52-24WD	M52x2	G1.1/2"x11	42	55	52	19	22	42	55	60	343	250	

注：如需带卡套及卡套螺母整套订货，则请在代号后加“RN”，如Q1CB-30-12WD/RN

Note: In case if you are interested to order the adapter in complete set with cutting ring and nut, it is necessary to insert suffix "RN" after our part No., for example Q1CB-30-12WD/RN

过渡接头 ADAPTER 公制 DIN 卡套式 METRIC Thread Bite Type Tube Fitting

Q1DB-WD Q1DB-WD/RN

英管螺纹胶垫密封柱端或60°锥密封
BSP Thread With Captive Seal or 60° Seat Sealing

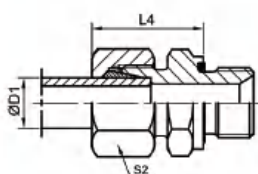
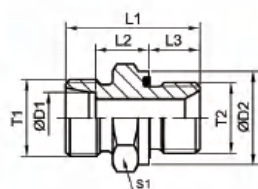

代号 PART NO.	螺纹 THREAD		管子外径		尺寸 DIMENSIONS						重量 克/件	工作压力 (bar)	系列	
	T1	T2	D1	D2	L1	L2	L3	L4	S1	S2				
Q1DB-14-02WD	M14x1.5	G1/8"x28	06	14	27.5	12.5	8	27	14	17	21	500		
Q1DB-14-04WD	M14x1.5	G1/4"x19	06	19	32	13	12	28	19	17	35	800		
Q1DB-14-06WD	M14x1.5	G3/8"x19	06	22	34.5	15.5	12	30	22	17	52	630		
Q1DB-14-08WD	M14x1.5	G1/2"x14	06	27	39	18	14	33	27	27	83	630		
Q1DB-16-04WD	M16x1.5	G1/4"x19	08	19	34	15	12	30	19	19	41	800		
Q1DB-16-06WD	M16x1.5	G3/8"x19	08	22	34.5	15.5	12	30	22	19	57	800		
Q1DB-16-08WD	M16x1.5	G1/2"x14	08	27	39	18	14	33	27	19	89	630		
Q1DB-18-04WD	M18x1.5	G1/4"x19	10	19	34	14.5	12	31	19	22	42	800		
Q1DB-18-06WD	M18x1.5	G3/8"x19	10	22	34.5	15	12	31	22	22	55	800		
Q1DB-18-08WD	M18x1.5	G1/2"x14	10	27	39	17.5	14	34	27	22	97	630		
Q1DB-20-04WD	M20x1.5	G1/4"x19	12	19	36	16.5	12	33	22	24	61	630		
Q1DB-20-06WD	M20x1.5	G3/8"x19	12	22	36.5	17	12	33	22	24	62	630		
Q1DB-20-08WD	M20x1.5	G1/2"x14	12	27	39	17.5	14	34	27	24	99	630		
Q1DB-22-06WD	M22x1.5	G3/8"x19	14	22	38.5	18.5	12	36	24	27	74	420		
Q1DB-22-08WD	M22x1.5	G1/2"x14	14	27	41	19	14	37	27	27	96	630		
Q1DB-22-12WD	M22x1.5	G3/4"x14	14	32	45	21	16	39	32	27	138	630		
Q1DB-24-06WD	M24x1.5	G3/8"x19	16	22	38.5	18	12	36	27	30	83	420		
Q1DB-24-08WD	M24x1.5	G1/2"x14	16	27	41	18.5	14	37	27	30	91	420		
Q1DB-24-12WD	M24x1.5	G3/4"x14	16	32	45	20.5	16	39	32	30	152	420		
Q1DB-30-08WD	M30x2	G1/2"x14	20	27	45	20.5	14	42	32	36	142	420		
Q1DB-30-12WD	M30x2	G3/4"x14	20	32	47	20.5	16	42	32	36	149	420		
Q1DB-30-16WD	M30x2	G1"x11	20	40	51	22.5	18	44	41	36	265	420		
Q1DB-30-20WD	M30x2	G1.1/4"x11	20	50	53	22.5	20	44	50	36	404	420		
Q1DB-36-08WD	M36x2	G1/2"x14	25	27	49	23	14	47	41	46	228	420		
Q1DB-36-12WD	M36x2	G3/4"x14	25	32	51	23	16	47	41	46	266	420		
Q1DB-36-16WD	M36x2	G1"x11	25	40	53	23	18	47	41	46	404	420		
Q1DB-36-20WD	M36x2	G1.1/4"x11	25	50	55	23	20	47	50	46	411	420		
Q1DB-36-24WD	M36x2	G1.1/2"x11	25	55	60	26	22	50	55	46	549	315		
Q1DB-42-16WD	M42x2	G1"x11	30	40	55	23.5	18	50	46	50	344	420		
Q1DB-42-20WD	M42x2	G1.1/4"x11	30	50	57	23.5	20	50	50	50	418	420		
Q1DB-42-24WD	M42x2	G1.1/2"x11	30	55	62	26.5	22	53	55	50	530	315		
Q1DB-52-20WD	M52x2	G1.1/4"x11	38	50	62	26	20	57	55	60	575	420		
Q1DB-52-24WD	M52x2	G1.1/2"x11	38	55	64	26	22	57	55	60	563	420		

注：如需带卡套及卡套螺母整套订货，则在代号后加“RN”，如Q1DB-30-12WD/RN。

Note: In case if you are interested to order the adapter in complete set with cutting ring and nut, it is necessary to insert suffix "RN" after our part No., for example Q1DB-30-12WD/RN.

过渡接头 ADAPTER 公制 DIN 卡套式 METRIC Thread Bite Type Tube Fitting

Q1CM, Q1DM
Q1CM/RN, Q1DM/RN

Metric Male 公制外螺纹60°锥密封或组合垫密封两用柱端
60° Seat Sealing or Bonded Seal Stud Ends

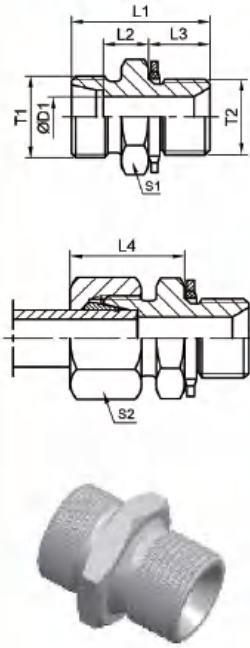

代号 PART NO.	螺纹 THREAD		管子外径 D1	尺寸 DIMENSIONS						重量 克/件	工作压力 (bar)	系列
	T1	T2		L1	L2	L3	L4	S1	S2			
Q1CM-12-10	M12x1.5	M10x1	06	23.5	8.5	8	23	14	14	13	500	L
Q1CM-14-12	M14x1.5	M12x1.5	08	29	10	10	25	17	17	22	500	
Q1CM-14-18	M14x1.5	M18x1.5	08	30.5	11.5	12	26	24	17	23	500	
Q1CM-16-14	M16x1.5	M14x1.5	10	30	11	11	26	19	19	29	500	
Q1CM-16	M16x1.5	M16x1.5	10	31.5	12.5	12	24	22	19	39	420	
Q1CM-16-18	M16x1.5	M18x1.5	10	31.5	12.5	12	27	24	19	49	400	
Q1CM-16-22	M16x1.5	M22x1.5	10	35	14	14	29	27	19	79	400	
Q1CM-18-14	M18x1.5	M14x1.5	12	30	11	11	26	19	22	30	400	
Q1CM-18-16	M18x1.5	M16x1.5	12	31.5	12.5	12	27	22	22	39	400	
Q1CM-18	M18x1.5	M18x1.5	12	31.5	12.5	12	27	24	22	46	400	
Q1CM-18-22	M18x1.5	M22x1.5	12	35	14	14	29	27	22	73	400	
Q1CM-22-16	M22x1.5	M16x1.5	15	32	13	12	28	24	27	50	400	
Q1CM-22-18	M22x1.5	M18x1.5	15	32.5	13.5	12	29	24	27	63	400	
Q1CM-22	M22x1.5	M22x1.5	15	36	15	14	30	27	27	75	400	
Q1CM-26-18	M26x1.5	M18x1.5	18	33.5	14	12	30	27	32	67	400	
Q1CM-26-22	M26x1.5	M22x1.5	18	36	14.5	14	31	27	32	72	400	
Q1CM-30-22	M30x2	M22x1.5	22	38	16.5	14	33	32	36	94	250	
Q1CM-30-26	M30x2	M26x1.5	22	40	16.5	16	33	32	36	100	250	
Q1CM-30-27	M30x2	M27x2	22	42	18.5	16	35	32	36	164	250	
Q1CM-36-33	M36x2	M33x2	28	43	17.5	18	34	41	41	275	250	
Q1CM-45-42	M45x2	M42x2	35	48	17.5	20	39	50	50	350	250	
Q1CM-52-48	M52x2	M48x2	42	52	19	22	42	55	60	355	250	
Q1DM-14-12	M14x1.5	M12x1.5	06	32	13	10	28	17	17	41	800	
Q1DM-16-14	M16x1.5	M14x1.5	08	34	15	11	30	19	19	53	800	
Q1DM-18-16	M18x1.5	M16x1.5	10	34.5	15	12	31	22	22	59	800	
Q1DM-20-18	M20x1.5	M18x1.5	12	36.5	17	12	33	24	24	70	630	
Q1DM-20-22	M20x1.5	M22x1.5	12	39	17.5	14	34	27	24	100	630	
Q1DM-22-20	M22x1.5	M20x1.5	14	41	19	14	37	27	27	96	630	
Q1DM-24-18	M24x1.5	M18x1.5	16	38.5	18	12	36	27	30	86	630	
Q1DM-24-22	M24x1.5	M22x1.5	16	41	18.5	14	37	27	30	93	800	
Q1DM-30-27	M30x2	M27x2	20	47	20.5	16	42	32	36	147	420	
Q1DM-36-33	M36x2	M33x2	25	53	23	18	47	41	46	260	420	
Q1DM-42	M42x2	M42x2	30	57	23.5	20	50	50	50	415	420	
Q1DM-52-48	M52x2	M48x2	38	64	26	22	57	55	60	560	420	

注：如需带卡套及卡套螺母整套订货，则请在代号后加“RN”，如Q1CM-30-27/RN。

Note: In case if you are interested to order the adapter in complete set with cutting ring and nut, it is necessary to insert suffix "RN" after our part No., for example Q1CM-30-27/RN.

过渡接头 ADAPTER 公制 DIN 卡套式 METRIC Thread Bite Type Tube Fitting

Q1CM-WD, Q1DM-WD Q1CM-WD/RN, Q1DM-WD/RN

公制外螺纹胶垫密封柱端或60°锥密封 Metric Thread With Captive Seal or 60° Seat Sealing

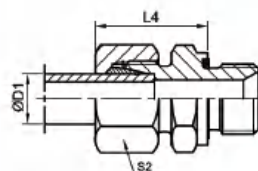
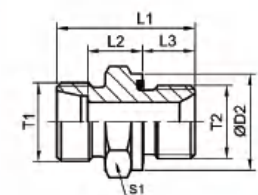

代号 PART NO.	螺纹 THREAD		管子外径		尺寸 DIMENSIONS						重量 克/件	工作压力 (bar)	系列
	T1	T2	D1	D2	L1	L2	L3	L4	S1	S2			
Q1CM-12-10WD	M12x1.5	M10x1	06	14	23.5	8.5	8	23	14	14	13	500	L
Q1CM-14-12WD	M14x1.5	M12x1.5	08	17	29	10	12	25	17	17	22	500	
Q1CM-16-12WD	M16x1.5	M12x1.5	10	17	30	11	12	26	17	19	23	500	
Q1CM-16-14WD	M16x1.5	M14x1.5	10	19	30	11	12	26	19	19	29	500	
Q1CM-16WD	M16x1.5	M16x1.5	10	22	31.5	12.5	12	24	22	19	40	420	
Q1CM-16-18WD	M16x1.5	M18x1.5	10	24	31.5	12.5	12	27	24	19	50	400	
Q1CM-16-22WD	M16x1.5	M22x1.5	10	27	35	14	14	29	27	19	80	400	
Q1CM-18-14WD	M18x1.5	M14x1.5	12	19	30	11	12	26	19	22	30	400	
Q1CM-18-16WD	M18x1.5	M16x1.5	12	22	31.5	12.5	12	27	22	22	40	400	
Q1CM-18WD	M18x1.5	M18x1.5	12	24	31.5	12.5	12	27	24	22	47	400	
Q1CM-18-22WD	M18x1.5	M22x1.5	12	27	35	14	14	29	27	22	75	400	
Q1CM-22-16WD	M22x1.5	M16x1.5	15	22	32	13	12	28	24	27	64	400	
Q1CM-22-18WD	M22x1.5	M18x1.5	15	24	32.5	13.5	12	29	24	27	51	400	
Q1CM-22WD	M22x1.5	M22x1.5	15	27	36	15	14	30	27	27	77	400	
Q1CM-26-18WD	M26x1.5	M18x1.5	18	24	33.5	14	12	30	27	32	68	400	
Q1CM-26-22WD	M26x1.5	M22x1.5	18	27	36	14.5	14	31	27	32	74	400	
Q1CM-30-22WD	M30x2	M22x1.5	22	32	27	16.5	14	33	32	36	97	250	
Q1CM-30-26WD	M30x2	M26x1.5	22	32	40	16.5	16	33	32	36	103	250	
Q1CM-30-27WD	M30x2	M27x2	22	32	40	16.5	16	33	32	36	106	250	
Q1CM-36-33WD	M36x2	M33x2	28	40	43	17.5	18	34	41	41	168	250	
Q1CM-45-42WD	M45x2	M42x2	35	50	48	17.5	20	39	50	50	281	250	
Q1CM-52-48WD	M52x2	M48x2	42	55	52	19	22	42	55	60	356	250	
Q1DM-14-12WD	M14x1.5	M12x1.5	06	17	32	13	12	28	17	17	30	800	S
Q1DM-16-14WD	M16x1.5	M14x1.5	08	19	34	15	12	30	19	19	42	800	
Q1DM-18-16WD	M18x1.5	M16x1.5	10	22	34.5	15	12	31	22	22	54	800	
Q1DM-20-14WD	M20x1.5	M14x1.5	12	19	36	16.5	12	33	22	24	60	630	
Q1DM-20-18WD	M20x1.5	M18x1.5	12	24	36.5	17	12	33	24	24	71	630	
Q1DM-20-22WD	M20x1.5	M22x1.5	12	27	39	17.5	14	34	27	24	102	630	
Q1DM-22-20WD	M22x1.5	M20x1.5	14	26	41	19	14	37	27	27	98	630	
Q1DM-24-18WD	M24x1.5	M18x1.5	16	24	38.5	18	12	36	27	30	88	630	
Q1DM-24-22WD	M24x1.5	M22x1.5	16	27	41	18.5	14	37	27	30	95	800	
Q1DM-30-27WD	M30x2	M27x2	20	32	47	20.5	16	42	32	36	150	420	
Q1DM-36-33WD	M36x2	M33x2	25	40	53	23	18	47	41	46	264	420	
Q1DM-42WD	M42x2	M42x2	30	50	57	23.5	20	50	50	50	422	420	
Q1DM-52-48WD	M52x2	M48x2	38	55	64	26	22	57	55	60	569	420	

注：如需带卡套及卡套螺母整套订货，则请在代号后加“RN”，如Q1CM-30-27WD/RN。
Note: In case if you are interested to order the adapter in complete set with cutting ring and nut, it is necessary to insert suffix "RN" after our part No., for example Q1CM-30-27WD/RN.

过渡接头 ADAPTER 公制 DIN 卡套式 METRIC Thread Bite Type Tube Fitting

Q1CG
Q1CG/RN

英管螺纹O型圈密封柱端
BSP Thread Stud Ends With O-Ring Sealing

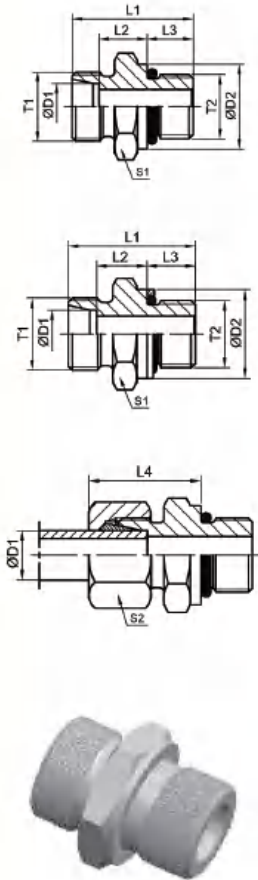

代号 PART No.	螺纹 THREAD		管子外径 TUDE		尺寸 DIMENSIONS								重量 克/件	工作压力 (bar)	系列
	T1	T2	D1	D2	L1	L2	L3	L4	S1	S2					
Q1CG-12-02	M12x1.5	G1/8"x28	06	14	23.5	8.5	8	23	14	14	14	14	315		
Q1CG-12-04	M12x1.5	G1/4"x19	06	18	29	10	12	25	19	14	60	315			
Q1CG-12-06	M12x1.5	G3/8"x19	06	22	30.5	11.5	12	26	22	14	45	315			
Q1CG-12-08	M12x1.5	G1/2"x14	06	26	33	12	14	27	27	14	60	315			
Q1CG-14-02	M14x1.5	G1/8"x28	08	14	23.5	8.5	8	23	14	17	16	315			
Q1CG-14-04	M14x1.5	G1/4"x19	08	18	29	10	12	25	19	17	26	315			
Q1CG-14-06	M14x1.5	G3/8"x19	08	22	30.5	11.5	12	26	22	17	44	315			
Q1CG-14-08	M14x1.5	G1/2"x14	08	26	33	12	14	27	27	17	74	315			
Q1CG-16-02	M16x1.5	G1/8"x28	10	14	25.5	10.5	8	25	17	19	21	315			
Q1CG-16-04	M16x1.5	G1/4"x19	10	18	30	11	12	26	19	19	31	315			
Q1CG-16-06	M16x1.5	G3/8"x19	10	22	31.5	12.5	12	27	22	19	44	315			
Q1CG-16-08	M16x1.5	G1/2"x14	10	26	34	13	14	28	27	19	72	315			
Q1CG-18-02	M18x1.5	G1/8"x28	12	14	26.5	11.5	8	26	19	22	27	315			
Q1CG-18-04	M18x1.5	G1/4"x19	12	18	31	12	12	27	19	22	32	315			
Q1CG-18-06	M18x1.5	G3/8"x19	12	22	31.5	12.5	12	27	22	22	43	315			
Q1CG-18-08	M18x1.5	G1/2"x14	12	26	34	13	14	28	27	22	67	315			
Q1CG-18-12	M18x1.5	G3/4"x14	12	32	37	14	16	29	32	22	120	315			
Q1CG-22-06	M22x1.5	G3/8"x19	15	22	32.5	13.5	12	29	24	27	56	250			
Q1CG-22-08	M22x1.5	G1/2"x14	15	26	35	14	14	29	27	27	72	250	L		
Q1CG-22-12	M22x1.5	G3/4"x14	15	32	38	15	16	30	32	27	118	250			
Q1CG-26-06	M26x1.5	G3/8"x19	18	22	33.5	14	12	29.5	27	32	69	250			
Q1CG-26-08	M26x1.5	G1/2"x14	18	26	36	14.5	14	31	27	32	72	250			
Q1CG-26-12	M26x1.5	G3/4"x14	18	32	38	14.5	16	30	32	32	112	250			
Q1CG-30-08	M30x2	G1/2"x14	22	26	38	16.5	14	33	32	36	91	160			
Q1CG-30-12	M30x2	G3/4"x14	22	32	40	16.5	16	33	32	36	103	160			
Q1CG-30-16	M30x2	G1"x11	22	39	43	17.5	18	33.5	41	36	184	160			
Q1CG-36-08	M36x2	G1/2"x14	28	26	39	17.5	14	34	41	41	141	160			
Q1CG-36-12	M36x2	G3/4"x14	28	32	41	17.5	16	34	41	41	156	160			
Q1CG-36-16	M36x2	G1"x11	28	39	43	17.5	18	34	41	41	168	160			
Q1CG-36-20	M36x2	G1.1/4x11	28	50	46	18.3	20	35	41	41	314	160			
Q1CG-45-12	M45x2	G3/4"x14	35	32	44	17.5	16	39	46	50	202	160			
Q1CG-45-16	M45x2	G1"x11	35	39	46	17.5	18	39	46	50	234	160			
Q1CG-45-20	M45x2	G1.1/4x11	35	50	48	17.5	20	39	46	50	276	160			
Q1CG-45-24	M45x2	G1.1/2x11	35	55	52	19.5	22	41	55	50	355	160			
Q1CG-52-16	M52x2	G1"x11	42	39	48	19	18	42	55	60	327	160			
Q1CG-52-20	M52x2	G1.1/4x11	42	50	50	19	20	42	55	60	336	160			
Q1CG-52-24	M52x2	G1.1/2x11	42	55	52	19	22	42	55	60	349	160			

Q1DG
Q1DG/RN

英管螺纹O型圈密封柱端
BSP Thread Stud Ends With O-Ring Sealing

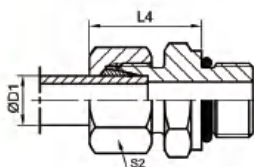
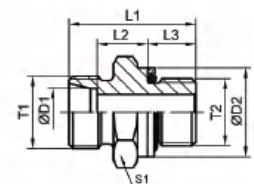
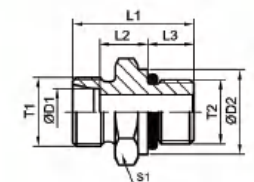

代号 PART No.	螺纹 THREAD		管子外径 TUDE		尺寸 DIMENSIONS						重量 克/件	工作压力 (bar)	系列
	T1	T2	D1	D2	L1	L2	L3	L4	S1	S2			
Q1DG-14-02	M14x1.5	G1/8"x28	06	14	27.5	12.5	8	27	14	17	22	400	S
Q1DG-14-04	M14x1.5	G1/4"x19	06	18	32	13	12	28	19	17	35	400	
Q1DG-14-06	M14x1.5	G3/8"x19	06	22	34.5	15.5	12	30	22	17	57	400	
Q1DG-14-08	M14x1.5	G1/2"x14	06	26	39	18	14	33	27	17	83	400	
Q1DG-16-04	M16x1.5	G1/4"x19	08	18	34	15	12	30	19	19	41	400	
Q1DG-16-06	M16x1.5	G3/8"x19	08	22	34.5	15.5	12	30	22	19	59	400	
Q1DG-16-08	M16x1.5	G1/2"x14	08	26	39	18	14	33	27	19	100	400	
Q1DG-18-04	M18x1.5	G1/4"x19	10	18	34	14.5	12	31	19	22	43	400	
Q1DG-18-06	M18x1.5	G3/8"x19	10	22	34.5	15	12	31	22	22	56	400	
Q1DG-18-08	M18x1.5	G1/2"x14	10	26	39	17.5	14	34	27	22	97	400	
Q1DG-20-04	M20x1.5	G1/4"x19	12	18	36	16.5	12	33	22	24	57	400	
Q1DG-20-06	M20x1.5	G3/8"x19	12	22	36.5	17	12	33	22	24	52	400	
Q1DG-20-08	M20x1.5	G1/2"x14	12	26	39	17.5	14	34	27	24	57	400	
Q1DG-22-06	M22X1.5	G3/8"X19	14	22	38.5	18.5	12	36	24	27	74	400	
Q1DG-22-08	M22X1.5	G1/2"X14	14	26	41	19	14	37	27	27	96	400	
Q1DG-24-06	M24X1.5	G3/8"X19	16	22	38.5	18	12	36	27	30	83	400	
Q1DG-24-08	M24X1.5	G1/2"X14	16	26	41	18.5	14	37	27	30	92	400	
Q1DG-24-12	M24X1.5	G3/4"X14	16	32	45	20.5	16	39	32	30	157	400	
Q1DG-30-08	M30X2	G1/2"X14	20	26	45	20.5	14	42	32	36	142	400	
Q1DG-30-12	M30X2	G3/4"X14	20	32	47	20.5	16	42	32	36	151	400	
Q1DG-30-16	M30X2	G1"X11	20	39	51	22.5	18	44	41	36	273	250	
Q1DG-30-20	M30X2	G1.1/4X11	20	50	53	22.5	20	44	50	36	387	160	
Q1DG-36-12	M36X2	G3/4"X14	25	32	51	23	16	47	41	46	245	250	
Q1DG-36-16	M36X2	G1"X11	25	39	53	23	18	47	41	46	267	250	
Q1DG-36-20	M36X2	G1.1/4X11	25	50	55	23	20	47	50	46	422	160	
Q1DG-42-16	M42X2	G1"X11	30	39	55	23.5	18	50	46	50	337	160	
Q1DG-42-20	M42X2	G1.1/4X11	30	41	57	23.5	20	50	50	50	422	160	
Q1DG-52-20	M52X2	G1.1/4X11	38	50	62	26	20	57	55	60	578	160	
Q1DG-52-24	M52X2	G1.1/2X11	38	55	64	26	22	57	55	60	560	160	

注：如需带卡套及卡套螺母整套订货，则请在代号后加“RN”，如Q1CG-30-12/RN；

如需配挡圈请在代号后加“DQ”，如Q1CG-30-12/DQ。

Note: In case if you are interested to order the adapter in complete set with cutting ring and nut, it is necessary to insert suffix "RN" after our part No., for example Q1CG-30-12/RN;

with retainer ring please insert suffix "DQ" after our part No. ,for example Q1CG-30-12/DQ.

过渡接头 ADAPTER 公制 DIN 卡套式 METRIC Thread Bite Type Tube Fitting

Q1CH, Q1DH
Q1CH/RN, Q1DH/RN

公制外螺纹柱端 ISO 6149
Metric Thread Stud Ends ISO 6149

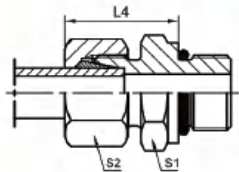
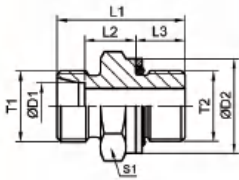
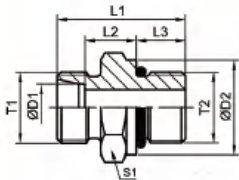

代号 PART NO.	螺纹 THREAD		管子外径		尺寸 DIMENSIONS						重量 克/件	工作压力 (bar)	系列
	T1	T2	D1	D2	L1	L2	L3	L4	S1	S2			
Q1CH-12-10	M12x1.5	M10x1	06	14	24	8.5	8.5	23	14	14	15	500	L
Q1CH-14-12	M14x1.5	M12x1.5	08	17	28	10	11	25	17	17	23	500	
Q1CH-16-14	M16x1.5	M14x1.5	10	19	29	11	11	26	19	19	28	500	
Q1CH-16	M16x1.5	M16x1.5	10	22	31	12.5	11.5	27.5	22	22	40	420	
Q1CH-18-16	M18x1.5	M16x1.5	12	22	31	12.5	11.5	27	22	22	42	400	
Q1CH-18	M18x1.5	M18x1.5	12	24	33	13.5	12.5	28	24	22	51	400	
Q1CH-22-18	M22x1.5	M18x1.5	15	24	33	13.5	12.5	29	24	27	56	400	
Q1CH-22	M22x1.5	M22x1.5	15	27	34.5	14.5	13	30	27	27	74	400	
Q1CH-26-22	M26x1.5	M22x1.5	18	27	35	14.5	13	31	27	32	80	400	
Q1CH-26	M26x1.5	M26x1.5	18	31.9	38	14.5	16	31	32	32	108	400	
Q1CH-30-26	M30x2	M26x1.5	22	31.9	40	16.5	16	33	32	36	107	250	
Q1CH-30-27	M30x2	M27x2	22	32	40	16.5	16	33	32	36	104	250	
Q1CH-36-33	M36x2	M43x2	28	41	41	17.5	16	34	41	41	171	250	
Q1CH-45-42	M45x2	M42x2	35	50	44	17.5	16	39	50	50	278	250	
Q1CH-52-48	M52x2	M48x2	42	55	47.5	19	17.5	42	55	60	340	250	
Q1DH-14-12	M14x1.5	M16x1.5	06	17	31	13	11	28	17	17	29	800	S
Q1DH-16-14	M16x1.5	M14x1.5	08	19	33	15	11	30	19	19	37	800	
Q1DH-16	M16x1.5	M16x1.5	08	22	35	15	12.5	31	22	19	50	800	
Q1DH-18-16	M18x1.5	M16x1.5	10	22	35	15	12.5	31	22	22	55	800	
Q1DH-18	M18x1.5	M18x1.5	10	24	38.5	17	14	33	24	22	71	630	
Q1DH-20-18	M20x1.5	M18x1.5	12	24	38.5	17	14	33	24	24	73	630	
Q1DH-24-22	M24x1.5	M22x1.5	16	27	42	18.5	15	37	27	30	102	630	
Q1DH-30-27	M30x2	M27x2	20	32	49.5	20.5	18.5	42	32	36	169	420	
Q1DH-36-33	M36x2	M33x2	25	41	53.5	23	18.5	47	41	46	274	420	
Q1DH-42	M42x2	M42x2	30	50	56	23	19	50	50	50	412	420	
Q1DH-52-48	M52x2	M48x2	38	55	63.5	26	21.5	57	55	60	580	420	

注：如需带卡套及卡套螺母整套订货，则请在代号后加“RN”，如Q1CH-30-27/RN；

如需配挡圈请在代号后加“DQ”，如Q1CH-30-27/DQ。

Note: In case if you are interested to order the adapter in complete set with cutting ring and nut, it is necessary to insert suffix “RN” after our part No., for example Q1CH-30-27/RN;

with retainer ring please insert suffix “DQ” after our part No., for example Q1CH-30-27/DQ.

Q1CO, Q1DO
Q1CO/RN, Q1DO/RN

管螺纹O型圈密封柱端 ISO 11926

UN.UNF Thread Stud Ends With O-Ring Sealing ISO 11926

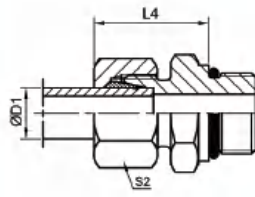
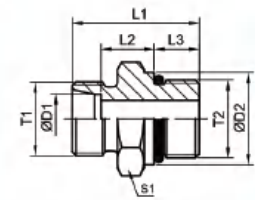

代号 PART NO.	螺纹 THREAD		管子外径		尺寸 DIMENSIONS							重量 克/件	工作压力 (bar)	系列
	T1	T2	D1	D2	L1	L2	L3	L4	S1	S2				
Q1CO-14-04	M14x1.5	7/16"x20UNF	08	-	26	10	9	25	17	17	21	315	L	
Q1CO-16-04	M16x1.5	7/16"x20UNF	10	-	27	11	9	26	17	19	23	315		
Q1CO-18-06	M18x1.5	9/16"x18UNF	12	-	28	11	10	26	19	22	32	315		
Q1CO-18-08	M18x1.5	3/4"x16UNF	12	-	31	13	11	28	24	22	52	315		
Q1CO-18-10	M18x1.5	7/8"x14UNF	12	-	34	14.3	12.7	29	27	22	77	315		
Q1CO-22-08	M22x1.5	3/4"x16UNF	15	-	32	14	11	29	24	27	57	315		
Q1CO-22-10	M22x1.5	7/8"x14UNF	15	-	35	15.3	12.7	30	27	27	81	315		
Q1CO-26-08	M26x1.5	3/4"x16UNF	18	23.9	33	14.5	11	31	27	32	68	315		
Q1CO-26-10	M26x1.5	7/8"x14UNF	18	-	35	14.8	12.7	31	27	32	72	315		
Q1CO-30-10	M30x2	7/8"x14UNF	22	26.9	37	16.8	12.7	33	32	36	94	160		
Q1CO-30-12	M30x2	1.1/16"x12UNF	22	-	39	16.5	15	33	32	36	103	160		
Q1CO-30-16	M30x2	1.5/16"x12UNF	22	-	40	17.5	15	34	41	36	163	160		
Q1CO-36-12	M36x2	1.1/16"x12UNF	28	33.3	40	17.5	15	34	41	41	152	160		
Q1CO-36-16	M36x2	1.5/16"x12UNF	28	-	40	17.5	15	34	41	41	163	160		
Q1CO-45-16	M45x2	1.5/16"x12UNF	35	39.6	43	17.5	15	39	46	50	222	160		
Q1CO-45-20	M45x2	15/8"x12UNF	35	-	43	17.5	15	39	50	50	257	160		
Q1CO-52-20	M52x2	15/8"x12UNF	42	47.7	45	19	15	42	55	60	339	160		
Q1DO-16-04	M16x1.5	7/16"x20UNF	08	-	31	13	11	30	17	19	33	630		
Q1DO-18-06	M18x1.5	9/16"x18UNF	10	-	32	12.5	12	31	19	22	42	630		
Q1DO-20-06	M20x1.5	9/16"x18UNF	12	19	32	12.5	12	31	22	24	50	630		
Q1DO-20-08	M20x1.5	3/4"x16UNF	12	-	36	14.5	14	34	24	24	73	630		
Q1DO-24-08	M24x1.5	3/4"x16UNF	16	-	35	12.5	14	34	24	30	90	400		
Q1DO-24-10	M24x1.5	7/8"x14UNF	16	-	40	15.5	16	37	27	30	95	400		
Q1DO-30-08	M30x2	3/4"x16UNF	20	23.9	42	17.5	14	42	32	36	132	400		
Q1DO-30-10	M30x2	7/8"x14UNF	20	26.9	44	17.5	16	42	32	36	141	400		
Q1DO-30-12	M30x2	1.1/16"x12UNF	20	-	46	17	18.5	42	32	36	163	400		
Q1DO-36-12	M36x2	1.1/16"x12UNF	25	33.3	50	19.5	18.5	47	36	46	206	400		
Q1DO-36-16	M36x2	1.5/16"x12UNF	25	-	50	19.5	18.5	47	41	46	258	400		
Q1DO-42-16	M42x2	1.5/16"x12UNF	30	39.6	52	20	18.5	50	46	50	327	400		
Q1DO-42-20	M42x2	15/8"x12UNF	30	-	52	20	18.5	50	50	50	422	400		
Q1DO-52-20	M52x2	15/8"x12UNF	38	47.7	57	22.5	18.5	57	55	60	554	315		

注：如需带卡套及卡套螺母整套订货，则请在代号后加“RN”，如Q1CO-30-12/RN。

Note: In case if you are interested to order the adapter in complete set with cutting ring and nut, it is necessary to insert suffix "RN" after our part No., for example Q1CO-30-12/RN.

过渡接头 ADAPTER 公制 DIN 卡套式 METRIC Thread Bite Type Tube Fitting

Q1CT-SP Q1CT-SP/RN

英锥管外螺纹
BSPT Male

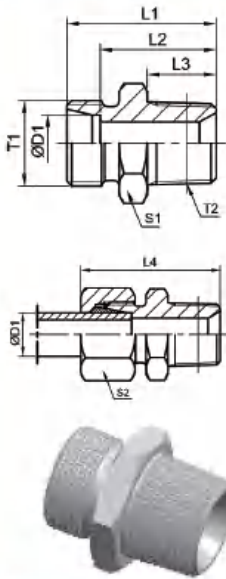

代号 PART NO.	螺纹 THREAD		管子外径 D1	尺寸 DIMENSIONS						重量 克/件	工作压力 (bar)	系列
	T1	T2		L1	L2	L3	L4	S1	S2			
Q1CT-12-02SP	M12x1.5	R1/8"x28	06	22	15	8	30	12	14	11	315	L
Q1CT-12-04SP	M12x1.5	R1/4"x19	06	27	20	12	35	17	14	24	315	
Q1CT-14-02SP	M14x1.5	R1/8"x28	08	23	16	8	31	17	17	15	315	
Q1CT-14-04SP	M14x1.5	R1/4"x19	08	27	20	12	35	17	17	22	315	
Q1CT-16-04SP	M16x1.5	R1/4"x19	10	28	21	12	36	17	19	24	315	
Q1CT-18-04SP	M18x1.5	R1/4"x19	12	29	22	12	37	19	22	53	315	
Q1CT-18-06SP	M18x1.5	R3/8"x19	12	29	22	12	37	19	22	33	315	
Q1CT-18-08SP	M18x1.5	R1/2"x14	12	31	24	14	39	24	22	53	315	
Q1CT-22-06SP	M22x1.5	R3/8"x19	15	30	23	12	38	24	27	49	315	
Q1CT-22-08SP	M22x1.5	R1/2"x14	15	32	25	14	40	24	27	59	315	
Q1CT-26-08SP	M26x1.5	R1/2"x14	18	33	25.5	14	42	27	32	64	315	
Q1CT-30-12SP	M30x2	R3/4"x14	22	37	29.5	16	46	32	36	99	160	
Q1CT-36-16SP	M36x2	R1"x11	28	40	32.5	18	49	41	41	154	160	
Q1CT-45-20SP	M45x2	R1.1/4"x44	35	45	34.5	20	56	46	50	238	160	
Q1CT-52-24SP	M52x2	R1.1/2"x11	42	49	38	22	61	55	60	335	160	

注：如需带卡套及卡套螺母整套订货，则请在代号后加“RN”，如Q1CT-30-12SP/RN。
Note: In case if you are interested to order the adapter in complete set with cutting ring and nut, it is necessary to insert suffix "RN" after our part No., for example Q1CT-30-12SP/RN.

Q1CN, Q1DN Q1CN/RN, Q1DN/RN

布锥管外螺纹
NPT Male

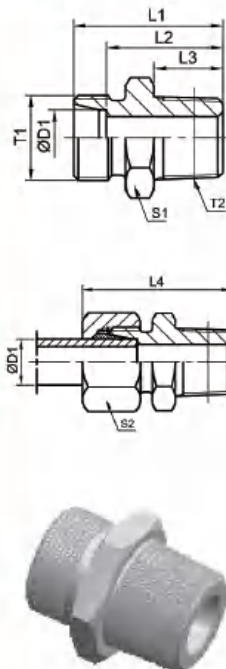

代号 PART NO.	螺纹 THREAD		管子外径 D1	尺寸 DIMENSIONS						重量 克/件	工作压力 (bar)	系列
	T1	T2		L1	L2	L3	L4	S1	S2			
Q1CN-12-02	M12x1.5	NPT 1/8"x27	6	24	17	10	32	12	14	12	315	L
Q1CN-12-04	M12x1.5	NPT 1/4"x18	6	30	23	14.5	38	17	14	27	315	
Q1CN-12-06	M12x1.5	NPT 3/8"x18	6	30	23	14.5	38	19	14	32	315	
Q1CN-12-08	M12x1.5	NPT 1/2"x14	6	36	29	19.5	44	22	14	53	315	
Q1CN-14-02	M14x1.5	NPT 1/8"x27	8	25	18	10	33	14	17	16	315	
Q1CN-14-04	M14x1.5	NPT 1/4"x18	8	30	23	14.5	38	17	17	25	315	
Q1CN-14-06	M14x1.5	NPT 3/8"x18	8	30	23	14.5	38	19	17	34	315	
Q1CN-14-08	M14x1.5	NPT 1/2"x14	8	36	29	19.5	44	22	17	54	315	
Q1CN-16-02	M16x1.5	NPT 1/8"x27	10	25	18	10	33	17	19	19	315	
Q1CN-16-04	M16x1.5	NPT 1/4"x18	10	31	24	14.5	39	17	19	25	315	
Q1CN-16-06	M16x1.5	NPT 3/8"x18	10	32	25	14.5	40	19	19	40	315	
Q1CN-16-08	M16x1.5	NPT 1/2"x14	10	37	30	19.5	45	22	19	54	315	
Q1CN-16-12	M16x1.5	NPT 3/4"x14	10	38	31	19.5	46	30	19	93	315	
Q1CN-18-02	M18x1.5	NPT 1/8"x27	12	26	19	10	34	19	22	52	315	
Q1CN-18-04	M18x1.5	NPT 1/4"x18	12	32	25	14.5	40	19	22	31	315	
Q1CN-18-06	M18x1.5	NPT 3/8"x18	12	32	25	14.5	40	19	22	37	315	
Q1CN-18-08	M18x1.5	NPT 1/2"x14	12	37	30	19.5	45	22	22	62	315	
Q1CN-22-06	M22x1.5	NPT 3/8"x18	15	33	26	14.5	41	24	27	53	315	
Q1CN-22-08	M22x1.5	NPT 1/2"x14	15	38	31	19.5	46	24	27	63	315	
Q1CN-22-12	M22x1.5	NPT 3/4"x14	15	39	32	19.5	47	30	27	112	315	
Q1CN-22-16	M22x1.5	NPT 1"x11.5	15	45	38	24.5	53	36	27	158	315	
Q1CN-26-06	M26x1.5	NPT 3/8"x18	18	34	26.5	14.5	43	27	32	69	315	
Q1CN-26-08	M26x1.5	NPT 1/2"x14	18	39	31.5	19.5	48	27	32	79	315	
Q1CN-26-12	M26x1.5	NPT 3/4"x14	18	39	31.5	19.5	48	30	32	104	315	
Q1CN-26-16	M26x1.5	NPT 1"x11.5	18	45	37.5	24.5	54	36	32	159	315	

过渡接头 ADAPTER 公制 DIN 卡套式 METRIC Thread Bite Type Tube Fitting

Q1CN, Q1DN
Q1CN/RN, Q1DN/RN

布锥管外螺纹
NPT Male

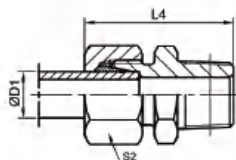
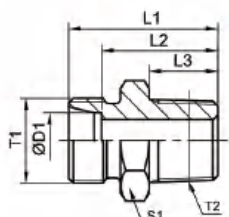

代号 PART NO.	螺纹 THREAD		管子外径 D1	尺寸 DIMENSIONS						重量 克/件	工作压力 (bar)	系列
	T1	T2		L1	L2	L3	L4	S1	S2			
Q1CN-30-06	M30x2	NPT 3/8"x18	22	36.5	29	14.5	45	32	36	91	315	L
Q1CN-30-08	M30x2	NPT 1/2"x14	22	41	33.5	19.5	50	32	36	96	160	
Q1CN-30-12	M30x2	NPT 3/4"x14	22	41	33.5	19.5	50	32	36	108	160	
Q1CN-30-16	M30x2	NPT 1"x11.5	22	47	39.5	24.5	56	36	36	174	160	
Q1CN-36-12	M36x2	NPT 3/4"x14	28	42	34.5	19.5	51	41	41	157	160	
Q1CN-36-16	M36x2	NPT 1"x11.5	28	47	39.5	24.5	56	41	41	197	160	
Q1CN-36-20	M36x2	NPT 1.1/4"x11.5	28	49	41.5	25	58	46	41	266	160	
Q1CN-45-16	M45x2	NPT 1"x11.5	35	50	39.5	24.5	61	46	50	280	160	
Q1CN-45-20	M45x2	NPT 1.1/4"x11.5	35	51	40.5	25	62	46	50	285	160	
Q1CN-52-20	M52x2	NPT 1.1/4"x11.5	42	53	42	25	65	55	60	382	160	
Q1CN-52-24	M52x2	NPT 1.1/2"x11.5	42	53	42	26	65	55	60	377	160	
Q1DN-14-02	M14x1.5	NPT 1/8"x27	06	28	21	10	36	14	17	21	630	
Q1DN-14-04	M14x1.5	NPT 1/4"x18	06	35	28	14.5	43	17	17	37	630	
Q1DN-14-06	M14x1.5	NPT 3/8"x18	06	33	26	14.5	41	19	17	40	630	
Q1DN-14-08	M14x1.5	NPT 1/2"x14	06	42	35	19.5	50	22	17	71	630	
Q1DN-16-04	M16x1.5	NPT 1/4"x18	08	35	28	14.5	43	19	19	38	630	
Q1DN-16-06	M16x1.5	NPT 3/8"x18	08	35	28	14.5	43	19	19	46	630	
Q1DN-16-08	M16x1.5	NPT 1/2"x14	08	42	35	19.5	50	22	19	73	630	
Q1DN-18-04	M18x1.5	NPT 1/4"x18	10	35	27.5	14.5	44	19	22	45	630	
Q1DN-18-06	M18x1.5	NPT 3/8"x18	10	35	27.5	14.5	44	19	22	49	630	
Q1DN-18-08	M18x1.5	NPT 1/2"x14	10	42	34.5	19.5	51	22	22	73	630	
Q1DN-18-12	M18x1.5	NPT 3/4"x14	10	44	36.5	19.5	53	30	22	125	630	
Q1DN-20-04	M20x1.5	NPT 1/4"x18	12	37	29.5	14.5	46	22	24	57	630	
Q1DN-20-06	M20x1.5	NPT 3/8"x18	12	37	29.5	14.5	46	22	24	62	630	
Q1DN-20-08	M20x1.5	NPT 1/2"x14	12	42	34.5	19.5	51	22	24	83	630	
Q1DN-20-12	M20x1.5	NPT 3/4"x14	12	44	36.5	19.5	53	30	24	126	630	
Q1DN-22-06	M22x1.5	NPT 3/8"x18	14	39	31	14.5	49	24	27	77	630	
Q1DN-22-08	M22x1.5	NPT 1/2"x14	14	44	36	19.5	54	24	27	89	630	
Q1DN-22-12	M22x1.5	NPT 3/4"x14	14	46	38	19.5	56	30	27	130	630	
Q1DN-22-16	M22x1.5	NPT 1"x11.5	14	51	43	24.5	61	36	27	180	630	
Q1DN-24-06	M24x1.5	NPT 3/8"x18	16	39	30.5	14.5	49	27	30	84	400	
Q1DN-24-08	M24x1.5	NPT 1/2"x14	16	48	39.5	19.5	58	27	30	97	400	
Q1DN-24-12	M24x1.5	NPT 3/4"x14	16	46	37.5	19.5	56	30	30	130	400	
Q1DN-24-16	M24x1.5	NPT 1"x11.5	16	53	44.5	24.5	61	36	30	178	400	
Q1DN-30-08	M30x2	NPT 1/2"x14	20	48	37.5	19.5	59	32	36	144	400	
Q1DN-30-12	M30x2	NPT 3/4"x14	20	48	37.5	19.5	59	32	36	149	400	
Q1DN-30-16	M30x2	NPT 1"x11.5	20	55	44.5	24.5	66	36	36	243	400	
Q1DN-36-12	M36x2	NPT 3/4"x14	25	52	40	19.5	64	41	46	240	400	
Q1DN-36-16	M36x2	NPT 1"x11.5	25	57	45	24.5	69	41	46	278	400	
Q1DN-36-20	M36x2	NPT 1.1/4"x11.5	25	58	46	25	70	46	46	396	400	
Q1DN-36-24	M36x2	NPT 1.1/2"x11.5	25	61	49	26	73	50	46	469	400	
Q1DN-42-12	M42x2	NPT 3/4"x14	30	54	40.5	19.5	67	46	50	307	400	
Q1DN-42-16	M42x2	NPT 1"x11.5	30	59	45.5	24.5	72	46	50	343	400	
Q1DN-42-20	M42x2	NPT 1.1/4"x11.5	30	60	46.5	25	73	46	50	397	400	
Q1DN-42-24	M42x2	NPT 1.1/2"x11.5	30	60	46.5	26	73	50	50	440	400	
Q1DN-52-16	M52x2	NPT 1"x11.5	38	64	48	24.5	79	55	60	510	315	
Q1DN-52-20	M52x2	NPT 1.1/4"x11.5	38	65	49	25	80	55	60	535	315	
Q1DN-52-24	M52x2	NPT 1.1/2"x11.5	38	65	49	26	80	55	60	571	315	

注：如需带卡套及卡套螺母整套订货，则请在代号后加“RN”，如Q1CN-30-12SP/RN。
Note: In case if you are interested to order the adapter in complete set with cutting ring and nut, it is necessary to insert suffix "RN" after our part No., for example Q1CN-30-12SP/RN.

过渡接头 ADAPTER 公制 DIN 卡套式 METRIC Thread Bite Type Tube Fitting

Q2HC-W Q2HD-W

公制外螺纹柱端/公制内螺纹24°锥O型圈密封
Metric Threads Stud Ends/Metric Female 24° Cone O-ring Sealing

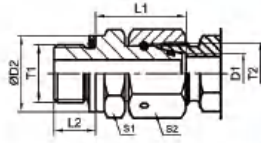

代号 PART NO.	螺纹 THREAD		管子外径		尺寸 DIMENSIONS				重量 克/件	工作压力 (Bar)	系列
	T1	T2	D1	D2	L1	L2	S1	S2			
Q2HC-10-12W	M10x1	M12x1.5	06	13.8	24.5	8.5	14	14	29	500	L
Q2HC-12-14W	M12x1.5	M14x1.5	08	16.8	26.5	11	17	17	43	500	
Q2HC-14-16W	M14x1.5	M16x1.5	10	18.8	27.5	11	19	19	57	500	
Q2HC-16-18W	M16x1.5	M18x1.5	12	21.8	30.5	11.5	22	22	85	400	
Q2HC-18-22W	M18x1.5	M22x1.5	15	23.8	31.5	12.5	24	27	115	400	
Q2HC-22-26W	M22x1.5	M26x1.5	18	26.8	31.5	13	27	32	452	400	
Q2HC-27-30W	M27x2	M30x2	22	31.8	32.5	16	32	36	207	250	
Q2HC-33-36W	M33x2	M36x2	28	40.8	35	16	41	41	294	250	
Q2HC-42-45W	M42x2	M45x2	35	49.8	42.5	16	50	50	516	250	
Q2HC-48-52W	M48	M52x2	42	54.8	46.5	17.5	55	60	718	250	
Q2HD-12-14W	M12x1.5	M14x1.5	06	16.8	27	11	17	17	49	800	S
Q2HD-14-16W	M14x1.5	M16x1.5	08	18.8	29.5	11	19	19	69	800	
Q2HD-16-18W	M16x1.5	M18x1.5	10	21.8	32	12.5	22	22	96	800	
Q2HD-18-20W	M18x1.5	M20x1.5	12	23.8	34	14	24	24	116	630	
Q2HD-22-24W	M22x1.5	M24x1.5	16	26.8	37	15	27	30	179	630	
Q2HD-27-30W	M27x2	M30x2	20	31.8	43	18.5	32	36	280	420	
Q2HD-33-36W	M33x2	M36x2	25	40.8	48	18.5	41	46	502	420	
Q2HD-42W	M42x2	M42x2	30	49.8	51	19	50	50	697	420	
Q2HD-48-52W	M48	M52x2	38	54.8	60	21.5	55	60	965	420	

注：如需配挡圈请在代号后加“DQ”，如Q2HD-33-36WDQ。

Note: If you interested to order the adapter with retainer ring please insert suffix

“DQ” after our part No. ,for example Q2HD-33-36WDQ.

Q2MC-WDW Q2MD-WDW

公制螺纹胶垫密封柱端60°锥密封/ 24°锥O型圈密封
Metric Threads With Captive Seal or 60° Seal Sealing
Metric Female 24° Cone O-ring Sealing

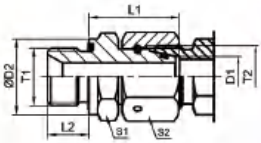

代号 PART NO.	螺纹 THREAD		管子外径		尺寸 DIMENSIONS				重量 克/件	工作压力 (bar)	系列
	T1	T2	D1	D2	L1	L2	S1	S2			
Q2MC-10-12WDW	M10x1	M12x1.5	06	14	24.5	8	14	14	27	500	L
Q2MC-12-14WDW	M12x1.5	M14x1.5	08	17	26.5	12	17	17	45	500	
Q2MC-14-16WDW	M14x1.5	M16x1.5	10	19	27.5	12	19	19	57	500	
Q2MC-16-18WDW	M16x1.5	M18x1.5	12	22	30.5	12	22	22	82	400	
Q2MC-22-18WDW	M22x1.5	M18x1.5	12	27	27	14	27	22	921	400	
Q2MC-18-22WDW	M18x1.5	M22x1.5	15	24	31.5	12	24	27	113	400	
Q2MC-22WDW	M22x1.5	M22x1.5	15	27	32	14	27	27	142	400	
Q2MC-22-26WDW	M22x1.5	M26x1.5	18	27	31.5	14	27	32	148	400	
Q2MC-27-30WDW	M27x1.5	M30x2	22	32	32.5	16	32	36	203	250	
Q2MC-33-36WDW	M33x2	M36x2	28	40	35	18	41	41	289	250	
Q2MC-42-45WDW	M42x2	M45x2	35	50	42.5	20	50	50	511	250	
Q2MC-48-52WDW	M48x2	M52x2	42	55	46.5	22	55	60	711	250	
Q2MD-12-14WDW	M12x1.5	M14x1.5	06	17	27	12	17	17	47	800	S
Q2MD-14-16WDW	M14x1.5	M16x1.5	08	19	29.5	12	19	19	65	800	
Q2MD-16-18WDW	M16x1.5	M18x1.5	10	22	32	12	22	22	91	800	
Q2MD-18-20WDW	M18x1.5	M20x1.5	12	24	34	12	24	24	112	630	
Q2MD-20-22WDW	M20x1.5	M22x1.5	14	26	36.5	14	27	27	153	630	
Q2MD-22-24WDW	M22x1.5	M24x1.5	16	27	37	14	27	30	174	630	
Q2MD-27-30WDW	M27x2	M30x2	20	32	43	16	32	36	274	420	
Q2MD-33-36WDW	M33x2	M36x2	25	40	48	18	41	46	497	420	
Q2MD-42WDW	M42x2	M42x2	30	50	51	20	50	50	691	420	
Q2MD-48-52WDW	M48x2	M52x2	38	55	60	22	55	60	957	420	

过渡接头 ADAPTER

公制 DIN 卡套式 METRIC Thread Bite Type Tube Fitting

Q2GC-W
Q2GD-W

公制内螺纹24°锥O型圈密封
BSP Thread Studs Ends With O-ring Sealing
Metric Female 24° Cone O-ring Sealing

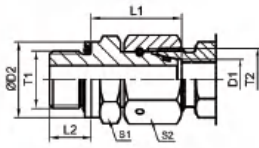

代号 PART NO.	螺纹 THREAD		管子外径		尺寸 DIMENSIONS					重量 克/件	工作压力 (Bar)	系列	
	T1	T2	D1	D2	L1	L2	S1	S2					
Q2GC-02-12W	G1/8"x28	M12x1.5	06	14	24.5	8	14	14		29	500	L	
Q2GC-04-14W	G1/4"x19	M14x1.5	08	19	29.5	12	19	17		30	500		
Q2GC-04-16W	G1/4"x19	M16x1.5	10	19	27.5	12	19	19		55	500		
Q2GC-06-16W	G3/8"x19	M16x1.5	10	22	29	12	22	19		75	400		
Q2GC-06-18W	G3/8"x19	M18x1.5	12	22	34	12	22	22		98	400		
Q2GC-04-18W	G1/4"x19	M18x1.5	12	19	27.5	12	19	22		67	400		
Q2GC-08-18W	G1/2"x14	M18x1.5	12	27	29.5	14	27	22		116	400		
Q2GC-08-22W	G1/2"x14	M22x1.5	15	27	32	14	27	27		140	400		
Q2GC-08-26W	G1/2"x14	M26x1.5	18	27	31.5	14	27	32		145	400		
Q2GC-12-26W	G3/4"x12	M26x1.5	18	32	32.5	16	32	32		185	250		
Q2GC-12-30W	G3/4"x12	M30x2	22	32	32.5	16	32	36		2004	250		
Q2GC-16-36W	G1"x11	M36x2	28	40	35	18	41	41		292	250		
Q2GC-20-45W	G1.1/4"x11	M45x2	35	50	42.5	20	50	50		506	250		
Q2GC-24-52W	G1.1/2"x11	M52x2	42	55	46.5	22	55	60		722	250		
Q2GD-04-14W	G1/4"x19	M14x1.5	06	19	27	12	19	17		55	800		S
Q2GD-04-16W	G1/4"x19	M16x1.5	08	19	29.5	12	19	19		66	800		
Q2GD-06-18W	G3/8"x19	M18x1.5	10	22	32	12	22	22		94	800		
Q2GD-06-20W	G3/8"x19	M20x1.5	12	22	34	12	22	24		103	630		
Q2GD-04-20W	G1/4"x19	M20x1.5	12	19	31.5	12	19	24		142	630		
Q2GD-08-20W	G1/2"x14	M20x1.5	12	27	35	14	27	24		142	630		
Q2GD-08-22W	G1/2"x14	M22x1.5	14	27	36.5	14	27	27		160	630		
Q2GD-08-24W	G1/2"x14	M24x1.5	16	27	37	14	27	30		173	630		
Q2GD-12-30W	G3/4"x12	M30x2	20	32	43	16	32	36		276	420		
Q2GD-16-36W	G1"x11	M36x2	25	40	48	18	41	46		496	420		
Q2GD-20-42W	G1.1/4"x11	M42x2	30	50	51	20	50	50		695	420		
Q2GD-24-52W	G1.1/2"x11	M52x2	38	55	60	22	55	60		938	420		

注：如需配挡圈请在代号后加“DQ”，如Q1GC-12-30WDQ。

Note: If you interested to order the adapter with retainer ring please insert suffix "DQ" after our part No. ,for example Q1GC-12-30WDQ.

过渡接头 ADAPTER 公制 DIN 卡套式 METRIC Thread Bite Type Tube Fitting

Q2BC-WDW
Q2BD-WDW

公制内螺纹24°锥O型圈密封
BSP Thread With Captive Seal or 60° Seal Sealing
Metric Female 24° Cone O-ring Sealing

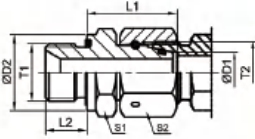

代号 PART NO.	螺纹 THREAD		管子外径		尺寸 DIMENSIONS				重量 克/件	工作压力 (bar)	系列
	T1	T2	D1	D2	L1	L2	S1	S2			
Q2BC-02-12WDW	G1/8"x28	M12x1.5	06	14	24.5	8	14	14	27	500	L
Q2BC-04-14WDW	G1/4"x19	M14x1.5	08	19	29.5	12	19	17	26	500	
Q2BC-04-16WDW	G1/4"x19	M16x1.5	10	19	27.5	12	19	19	54	500	
Q2BC-06-16WDW	G3/8"x19	M16x1.5	10	22	29	12	22	19	70	400	
Q2BC-06-18WDW	G3/8"x19	M18x1.5	12	22	34	12	22	22	95	400	
Q2BC-04-18WDW	G1/4"x19	M18x1.5	12	19	27.5	12	19	22	65	400	
Q2BC-08-18WDW	G1/2"x14	M18x1.5	12	27	29.5	14	27	22	114	400	
Q2BC-08-22WDW	G1/2"x14	M22x1.5	15	27	32	14	27	27	137	400	
Q2BC-08-26WDW	G1/2"x14	M26x1.5	18	27	31.5	14	27	32	143	400	
Q2BC-12-26WDW	G3/4"x12	M26x1.5	18	32	29.5	16	32	32	182	250	
Q2BC-12-30WDW	G3/4"x12	M30x2	22	32	32.5	16	32	36	200	250	
Q2BC-16-36WDW	G1"x11	M36x2	28	40	35	18	41	41	289	250	
Q2BC-20-45WDW	G1.1/4"x11	M45x2	35	50	42.5	20	50	50	500	250	
Q2BC-24-52WDW	G1.1/2"x11	M52x2	42	55	46.5	22	55	60	718	250	
Q2BD-04-14WDW	G1/4"x19	M14x1.5	06	19	27	12	19	17	53	800	S
Q2BD-04-16WDW	G1/4"x19	M16x1.5	08	19	29.5	12	19	19	64	800	
Q2BD-06-18WDW	G3/8"x19	M18x1.5	10	22	32	12	22	22	93	800	
Q2BD-06-20WDW	G3/8"x19	M20x1.5	12	22	34	12	22	24	100	630	
Q2BD-04-20WDW	G1/4"x19	M20x1.5	12	19	31.5	12	19	24	140	630	
Q2BD-08-20WDW	G1/2"x14	M20x1.5	12	27	35	14	27	24	140	630	
Q2BD-08-22WDW	G1/2"x14	M22x1.5	14	27	36.5	14	27	27	157	630	
Q2BD-08-24WDW	G1/2"x14	M24x1.5	16	27	37	14	27	30	170	630	
Q2BD-12-30WDW	G3/4"x12	M30x2	20	32	43	16	32	36	273	420	
Q2BD-16-36WDW	G1"x11	M36x2	25	40	48	18	41	46	493	420	
Q2BD-20-42WDW	G1.1/4"x11	M42x2	30	50	51	20	50	50	691	420	
Q2BD-24-52WDW	G1.1/2"x11	M52x2	38	55	60	22	55	60	934	420	

过渡接头 ADAPTER 公制 DIN 卡套式 METRIC Thread Bite Type Tube Fitting

Q1CG4-OG, Q1DG4-OG Q1CG4-OG/RN, Q1DG4-OG/RN

45°弯英管螺纹可调向O型圈密封柱端 45°Elbow BSP Thread Adjustable Stud Ends With O-ring Sealing

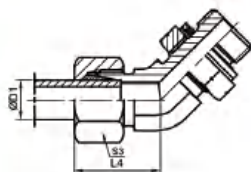
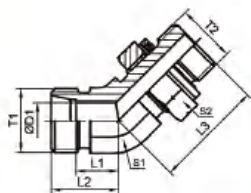

代号 PART NO.	螺纹 THREAD		管子外径 D1	尺寸 DIMENSIONS									重量 克/件	工作压力 (Bar)	系列
	T1	T2		L1	L2	L3	L4	S1	S2	S3					
Q1CG4-12-02OG	M12x1.5	G1/8"x28	06	9	16	28	24	14	14	14	30	315	L		
Q1CG4-14-04OG	M14x1.5	G1/4"x19	08	12	19	29	27	14	19	17	50	315			
Q1CG4-16-06OG	M16x1.5	G3/8"x19	10	15	22	30	30	16	22	22	81	315			
Q1CG4-18-06OG	M18x1.5	G3/8"x19	12	14	21	37	28	19	22	22	85	250			
Q1CG4-22-08OG	M22x1.5	G1/2"x14	15	17	24	39	32	22	27	27	150	250			
Q1CG4-26-08OG	M26x1.5	G1/2"x14	18	17	24.5	45	33	27	27	32	180	250			
Q1CG4-30-12OG	M30x2	G3/4"x14	22	19	26.5	50	35	30	36	36	276	160			
Q1CG4-36-16OG	M36x2	G1"x11	28	23	30.5	52	40	36	41	41	453	160			
Q1CG4-45-20OG	M45x2	G1.1/4"x11	35	27	37.5	54	48	50	50	50	680	160			
Q1CG4-52-24OG	M52x2	G1.1/2"x11	42	26	37	54	49	50	55	60	888	160			
Q1DG4-14-04OG	M14x1.5	G1/4"x19	06	9	16	28	24	14	19	17	57	315	S		
Q1DG4-16-04OG	M16x1.5	G1/4"x19	08	12	19	32	27	19	19	19	67	315			
Q1DG4-18-06OG	M18x1.5	G3/8"x19	10	13	20.5	34	29	19	22	22	92	250			
Q1DG4-20-06OG	M20x1.5	G3/8"x19	12	17	24.5	34	33	19	22	24	100	250			
Q1DG4-22-08OG	M22x1.5	G1/2"x14	14	22	30	40	36	22	27	27	153	250			
Q1DG4-24-08OG	M24x1.5	G1/2"x14	16	16	24.5	44	34	27	27	30	163	250			
Q1DG4-30-12OG	M30x2	G3/4"x14	20	16	26.5	46	38	27	36	36	284	250			
Q1DG4-36-16OG	M36x2	G1"x11	25	19	31	51	43	36	41	46	475	250			
Q1DG4-42-20OG	M42x2	G1.1/4"x11	30	24	37.5	53	50	50	50	50	577	160			

注：如需带卡套及卡套螺母整套订货，则请在代号后加“RN”，如Q1DG4-20-06OG/RN；
如需配挡圈请在代号后加“DQ”，如Q1DG4-20-06OGDQ。
Note: In case if you are interested to order the adapter in complete set with cutting ring and nut, it is necessary to insert suffix "RN" after our part No., for example Q1DG4-20-06OG/RN; with retainer ring please insert suffix "DQ" after our part No., for example Q1DG4-20-06OGDQ

Q1CG9-OG, Q1DG9-OG Q1CG9-OG/RN, Q1DG9-OG/RN

90°弯英管螺纹可调向O型圈密封柱端 90°Elbow BSP Thread Adjustable Stud Ends With O-ring Sealing

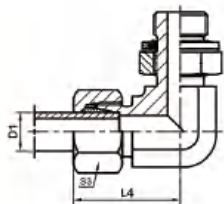
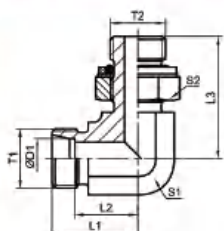

代号 PART NO.	螺纹 THREAD		管子外径 D1	尺寸 DIMENSIONS									重量 克/件	工作压力 (Bar)	系列
	T1	T2		L1	L2	L3	L4	S1	S2	S3					
Q1CG9-14-04OG	M14x1.5	G1/4"x19	08	23	16	32	31	14	19	17	59	315	L		
Q1CG9-16-04OG	M16x1.5	G1/4"x19	10	24	17	34	32	19	19	19	82	315			
Q1CG9-18-06OG	M18x1.5	G3/8"x19	12	26	19	37	34	19	22	22	96	250			
Q1CG9-22-08OG	M22x1.5	G1/2"x14	15	28	21	43	36	22	27	27	149	250			
Q1CG9-26-08OG	M26x1.5	G1/2"x14	18	31	24	49	40	27	27	32	221	250			
Q1CG9-30-12OG	M30x2	G3/4"x14	22	35	28	49	44	30	36	36	310	160			
Q1CG9-36-16OG	M36x2	G1"x11	28	38	31	59	47	36	41	41	455	160			
Q1CG9-45-20OG	M45x2	G1.1/4"x11	35	48	38	65	59	50	50	50	1043	160			
Q1CG9-52-24OG	M52x2	G1.1/2"x11	42	49	38	67	61	50	55	60	994	160			
Q1DG9-14-04OG	M14x1.5	G1/4"x19	06	22	15	32	30	14	19	17	56	315		S	
Q1DG9-16-04OG	M16x1.5	G1/4"x19	08	24	17	36	32	19	19	19	88	315			
Q1DG9-18-06OG	M18x1.5	G3/8"x19	10	25	18	38	34	19	22	22	98	250			
Q1DG9-20-06OG	M20x1.5	G3/8"x19	12	29	22	38	38	22	22	24	128	250			
Q1DG9-22-08OG	M22x1.5	G1/2"x14	14	30	22	43.2	40	22	27	27	147	250			
Q1DG9-24-08OG	M24x1.5	G1/2"x14	16	33	25	49	43	27	27	30	234	250			
Q1DG9-30-12OG	M30x2	G3/4"x14	20	38	28	51	49	30	36	36	344	250			
Q1DG9-36-16OG	M36x2	G1"x11	25	42	30	58	54	36	41	46	533	250			
Q1DG9-42-20OG	M42x2	G1.1/4"x11	30	49	36	64	62	50	50	50	1085	160			
Q1DG9-52-24OG	M52x2	G1.1/2"x11	38	50	34	70	65	50	55	60	111	160			

注：如需带卡套及卡套螺母整套订货，则请在代号后加“RN”，如Q1DG9-20-06OG/RN；
如需配挡圈请在代号后加“DQ”，如Q1DG9-20-06OGDQ。
Note: In case if you are interested to order the adapter in complete set with cutting ring and nut, it is necessary to insert suffix "RN" after our part No., for example Q1DG9-20-06OG/RN; with retainer ring please insert suffix "DQ" after our part No., for example Q1DG9-20-06OGDQ

过渡接头 ADAPTER 公制 DIN 卡套式 METRIC Thread Bite Type Tube Fitting

Q1CH4-OG, Q1DH4-OG Q1CH4-OG/RN, Q1DH4-OG/RN

45°弯公制外螺纹可调向柱端 ISO 6149
45°Elbow Male Adjustable Stud Ends ISO 6149

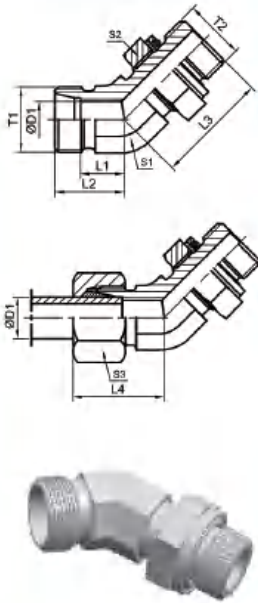

代号 PART NO.	螺纹 THREAD		管子外径			尺寸 DIMENSIONS						重量 克/件	工作压力 (Bar)	系列
	T1	T2	D1	L1	L2	L3	L4	S1	S2	S3				
Q1CH4-12-10OG	M12x1.5	M10x1	06	9	16	28	24	14	14	14	30	315	L	
Q1CH4-14-12OG	M14x1.5	M12x1.5	08	12	19	29	27	14	17	17	49	315		
Q1CH4-16-14OG	M16x1.5	M14x1.5	10	12	19	33	27	19	19	19	59	315		
Q1CH4-18-16OG	M18x1.5	M16x1.5	12	14	21	34	28	19	22	22	85	250		
Q1CH4-22-18OG	M22x1.5	M18x1.5	15	17	24	35	32	22	24	27	121	250		
Q1CH4-26-22OG	M26x1.5	M22x1.5	18	17	24.5	42	33	27	27	32	167	250		
Q1CH4-30-27OG	M30x2	M27x2	22	19	26.5	45	35	30	32	36	263	160		
Q1CH4-36-33OG	M36x2	M33x2	28	23	30.5	51	40	36	41	41	410	160		
Q1CH4-45-42OG	M45x2	M42x2	35	27	37.5	53	48	50	50	50	686	160		
Q1DH4-14-12OG	M14x1.5	M12x1.5	06	9	16	29	24	14	17	17	46	315		S
Q1DH4-16-14OG	M16x1.5	M14x1.5	08	12	19	29	27	19	19	19	59	315		
Q1DH4-18-16OG	M18x1.5	M16x1.5	10	13	20.5	34	29	19	22	22	85	250		
Q1DH4-20-18OG	M20x1.5	M18x1.5	12	17	24.5	37	33	19	24	24	117	250		
Q1DH4-24-22OG	M24x1.5	M22x1.5	16	16	24.5	44	34	19	27	30	185	250		
Q1DH4-30-27OG	M30x2	M27x2	20	16	26.5	51	38	27	32	36	165	250		
Q1DH4-36-33OG	M36x2	M33x2	25	19	31	53	43	36	41	46	410	250		
Q1DH4-42OG	M42x2	M42x2	30	24	37.5	54	50	50	50	50	672	160		

注：如需带卡套及卡套螺母整套订货，则请在代号后加“RN”，如Q1DH4-24-22OG/RN；
如需配挡圈请在代号后加“DQ”，如Q1DH4-24-22OGDQ。
Note: In case if you are interested to order the adapter in complete set with cutting ring and nut, it is necessary to insert suffix “RN” after our part No., for example Q1DH4-24-22OG/RN; with retainer ring please insert suffix “DQ” after our part No., for example Q1DH4-24-22OGDQ

Q1CH9-OG, Q1DH9-OG Q1CH9-OG/RN, Q1DH9-OG/RN

90°弯公制外螺纹可调向柱端 ISO 6149
90° Elbow Male Adjustable Stud Ends ISO 6149

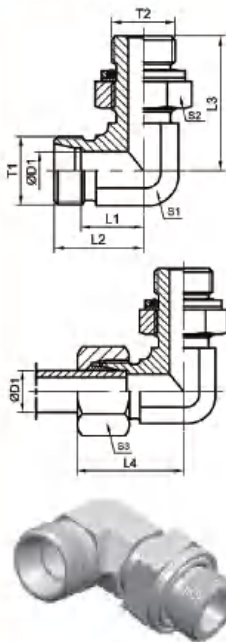

代号 PART NO.	螺纹 THREAD		管子外径			尺寸 DIMENSIONS						重量 克/件	工作压力 (Bar)	系列
	T1	T2	D1	L1	L2	L3	L4	S1	S2	S3				
Q1CH9-12-10OG	M12x1.5	M10x1	06	14	21	27	29	14	14	14	33	315	L	
Q1CH9-14-12OG	M14x1.5	M12x1.5	08	16	23	32	31	14	17	17	52	315		
Q1CH9-16-14OG	M16x1.5	M14x1.5	10	17	24	34	32	19	19	19	66	315		
Q1CH9-18-16OG	M18x1.5	M16x1.5	12	19	26	35	34	19	22	22	91	250		
Q1CH9-22-18OG	M22x1.5	M18x1.5	15	21	28	42	36	22	24	27	132	250		
Q1CH9-26-22OG	M26x1.5	M22x1.5	18	24	31.5	45	40	27	27	32	197	250		
Q1CH9-30-27OG	M30x2	M27x2	22	28	35.5	50	44	30	32	36	302	160		
Q1CH9-36-33OG	M36x2	M33x2	28	31	38.5	53	47	36	41	41	466	160		
Q1DH9-14-12OG	M14x1.5	M12x1.5	06	15	22	32	30	14	17	17	54	315		S
Q1DH9-16-14OG	M16x1.5	M14x1.5	08	17	24	36	32	19	19	19	68	315		
Q1DH9-18-16OG	M18x1.5	M16x1.5	10	18	25.5	38	34	19	22	22	93	250		
Q1DH9-20-18OG	M20x1.5	M18x1.5	12	22	29.5	43	38	22	24	24	126	250		
Q1DH9-22-20OG	M22x1.5	M20x1.5	14	22	30	40	40	22	27	27	161	250		
Q1DH9-24-22OG	M24x1.5	M22x1.5	16	25	33.5	50	43	27	27	30	183	250		
Q1DH9-30-27OG	M30x2	M27x2	20	28	38.5	54	49	30	32	36	309	250		
Q1DH9-36-33OG	M36x2	M33x2	25	30	42	60	54	36	41	46	487	250		
Q1DH9-42OG	M42x2	M42x2	30	36	49.5	68	62	50	50	50	773	160		

注：如需带卡套及卡套螺母整套订货，则请在代号后加“RN”，如Q1DH9-24-22OG/RN；
如需配挡圈请在代号后加“DQ”，如Q1DH9-24-22OGDQ。
Note: In case if you are interested to order the adapter in complete set with cutting ring and nut, it is necessary to insert suffix “RN” after our part No., for example Q1DH9-24-22OG/RN; with retainer ring please insert suffix “DQ” after our part No., for example Q1DH9-24-22OGDQ

过渡接头 ADAPTER 公制 DIN 卡套式 METRIC Thread Bite Type Tube Fitting

Q1CO4-OG, Q1DO4-OG
Q1CO4-OG/RN, Q1DO4-OG/RN

45°弯美制螺纹可调向O型圈密封柱端 ISO 1926
45°Elbow UN, UNF Thread Adjustable Stud Ends
With O-ring Sealing ISO 11926

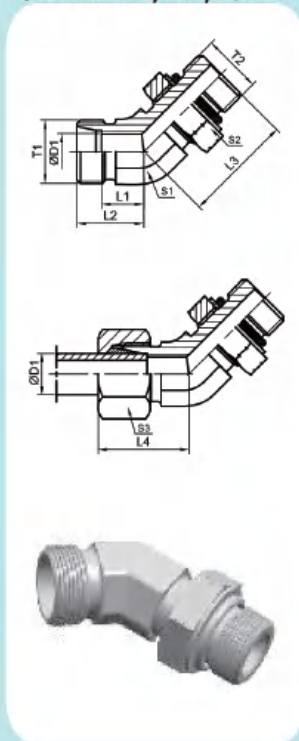

代号 PART NO.	螺纹 THREAD		管子外径		尺寸 DIMENSIONS							重量 克/件	工作压力 (bar)	系列
	T1	T2	D1	L1	L2	L3	L4	S1	S2	S3				
Q1CO4-12-04OG	M12x1.5	7/16"x20	06	9	16	29	24	14	17	14	40	315	L	
Q1CO4-14-06OG	M14x1.5	9/16"x18	08	12	19	29	27	14	19	14	53	315		
Q1CO4-16-06OG	M16x1.5	9/16"x18	10	12	19	34	27	19	19	19	64	315		
Q1CO4-18-08OG	M18x1.5	3/4"x16	12	14	21	37	28	19	22	22	110	250		
Q1CO4-22-10OG	M22x1.5	7/8"x14	15	17	24	39	32	22	27	27	151	250		
Q1CO4-22-08OG	M22x1.5	3/4"x16	15	17	24	37	32	22	22	27	128	250		
Q1CO4-26-12OG	M26x1.5	1.1/16"x12	18	17	24.5	47	33	30	32	32	140	250		
Q1CO4-30-12OG	M30x2	1.1/16"x12	22	19	26.5	50	35	30	32	36	275	160		
Q1CO4-36-16OG	M36x2	1.5/16"x12	28	23	30.5	52	39	36	41	41	429	160		
Q1CO4-45-20OG	M45x2	1.5/8"x12	35	27	37.5	54	48	50	50	50	670	160		
Q1CO4-52-24OG	M52x2	1.7/8"x12	42	26	37	54	49	50	55	60	847	160		
Q1DO4-14-04OG	M14x1.5	7/16"x20	06	9	16	30	24	14	14	17	43	315	S	
Q1DO4-16-06OG	M16x1.5	9/16"x18	08	12	19	33	27	19	19	19	62	315		
Q1DO4-18-06OG	M18x1.5	9/16"x18	10	13	20.5	33	29	19	19	22	70	250		
Q1DO4-20-08OG	M20x1.5	3/4"x16	12	17	24.5	36	33	22	22	24	125	250		
Q1DO4-24-10OG	M24x1.5	7/8"x14	16	16	23.5	45	34	27	27	30	176	250		
Q1DO4-30-12OG	M30x2	1.1/16"x12	20	16	36.5	50	38	30	32	36	310	250		
Q1DO4-36-16OG	M36x2	1.5/16"x12	25	30	42	52	54	36	32	46	486	250		
Q1DO4-42-20OG	M42x2	1.5/8"x12	30	24	37.5	54	50	50	50	50	662	160		
Q1DO4-52-24OG	M52x2	1.7/8"x12	38	21	37	54	52	50	55	60	837	160		

注：如需带卡套及卡套螺母整套订货，则请在代号后加“RN”，如Q1CO4-30-12OG/RN。
Note: In case if you are interested to order the adapter in complete set with cutting ring and nut, it is necessary to insert suffix "RN" after our part No., for example Q1CO4-30-12OG/RN.

过渡接头 ADAPTER 公制 DIN 卡套式 METRIC Thread Bite Type Tube Fitting

Q1C09-OG, Q1D09-OG
Q1C09-OG/RN, Q1D09-OG/RN

90°弯美制螺纹可调O型圈密封柱端 ISO 1926
90°Elbow UN, UNF Thread Adjustable Stud Ends
With O-Ring Sealing ISO 11926

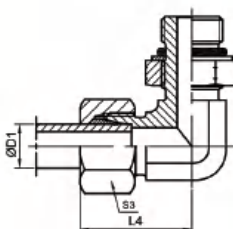
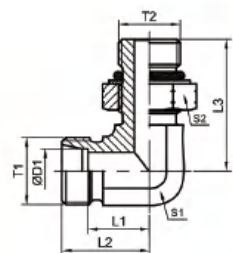

代号 PART NO.	螺纹 THREAD		管子外径 D1	尺寸 DIMENSIONS									重量 克/件	工作压力 (bar)	系列
	T1	T2		L1	L2	L3	L4	S1	S2	S3					
Q1C09-12-04OG	M12x1.5	7/16"x20	06	14	21	29	29	14	17	14	42	315	L		
Q1C09-14-06OG	M14x1.5	9/16"x18	08	15.5	22.5	31.8	30.5	14	19	17	60	315			
Q1C09-16-06OG	M16x1.5	9/16"x18	10	17	24	34	32	19	19	19	70	315			
Q1C09-18-08OG	M18x1.5	3/4"x16	12	19	26	38	34	19	22	22	118	250			
Q1C09-22-10OG	M22x1.5	7/8"x14	15	21	28	43	36	22	27	27	168	250			
Q1C09-22-08OG	M22x1.5	3/4"x16	15	21	28	41	36	22	22	27	144	250			
Q1C09-26-12OG	M26x1.5	1.1/16"x12	18	24	31.5	49	40	30	32	32	265	250			
Q1C09-30-12OG	M30x2	1.1/16"x12	22	28	35.5	52	44	30	32	36	313	160			
Q1C09-36-12OG	M36x2	1.5/16"x12	28	33.5	41	57.5	47.8	36	41	41	410	160			
Q1C09-36-16OG	M36x2	1.5/16"x12	28	31	38.5	59	47	36	41	41	500	160			
Q1C09-45-20OG	M45x2	1.5/8"x12	35	38	48.5	63	59	50	50	50	585	160			
Q1C09-52-24OG	M52x2	1.7/8"x12	42	38	49	64	61	50	55	60	582	160			
Q1D09-14-04OG	M14x1.5	7/16"x20	06	15	22	32	30	14	17	17	199	315		S	
Q1D09-16-06OG	M16x1.5	9/16"x18	08	17	24	37	32	19	19	19	226	315			
Q1D09-18-06OG	M18x1.5	9/16"x18	10	18	25.5	38	34	19	19	22	236	250			
Q1D09-18-06OG	M18x1.5	3/4"x16	10	19.5	27	37.5	36	19	24	22	281	250			
Q1D09-20-08OG	M20x1.5	3/4"x16	12	22	29.5	44	38	22	22	24	311	250			
Q1D09-22-10OG	M24x1.5	7/8"x14	14	23	30.5	44	41	22	27	27	328	250			
Q1D09-24-10OG	M24x1.5	7/8"x14	16	25	33.5	50	43	27	27	30	348	250			
Q1D09-30-12OG	M30x2	1.1/16"x12	20	28	38.5	56	49	30	32	36	430	250			
Q1D09-36-16OG	M36x2	1.5/16"x12	25	30	42	57.5	54	36	41	46	510	250			
Q1D09-42-20OG	M42x2	1.5/8"x12	30	36	49.5	69	62	50	50	50	695	160			
Q1D09-52-24OG	M52x2	1.7/8"x12	38	34	50	70	65	50	55	60	629	160			

注：如需带卡套及卡套螺母整套订货，则请在代号后加“RN”，如Q1C09-30-12OG/RN。
Note: In case if you are interested to order the adapter in complete set with cutting ring and nut, it is necessary to insert suffix "RN" after our part No., for example Q1C09-30-12OG/RN.

过渡接头 ADAPTER 公制 DIN 卡套式 METRIC Thread Bite Type Tube Fitting

QACCH-OG, QADDH-OG QACCH-OG/RN, QADDH-OG/RN

公制外螺纹可调向柱端 ISO 6149 主支三通 Metric Male Adjustable Stud Ends ISO 6149 Run Tee

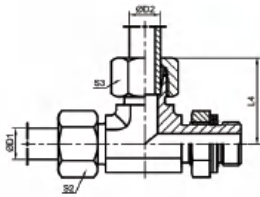
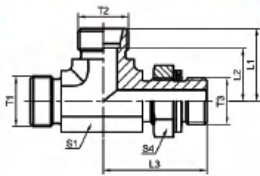

代号 PART NO.	螺纹 THREAD		管子外径		尺寸 DIMENSIONS							重量 克/件	工作压力 (bar)	系列
	T1/T2	T3	D1	D2	L1	L2	L3	L4	S1	S2/S3	S4			
QACCH-12-12-10OG	M12x1.5	M10x1	06	06	21	14	27	29	14	14	14	45	315	L
QACCH-14-14-12OG	M14x1.5	M12x1.5	08	08	23	16	32	31	14	17	17	68	315	
QACCH-16-16-14OG	M16x1.5	M14x1.5	10	10	24	17	34	32	19	19	19	89	315	
QACCH-18-18-16OG	M18x1.5	M16x1.5	12	12	26	19	35	34	19	22	22	121	250	
QACCH-22-22-18OG	M22x1.5	M18x1.5	15	15	28	21	41	36	22	27	24	177	250	
QACCH-26-26-22OG	M26x1.5	M22x1.5	18	18	31.5	24	44	40	27	32	27	263	250	
QACCH-30-30-27OG	M30x2	M27x2	22	22	35.5	28	49	44	30	36	32	396	160	S
QACCH-36-36-33OG	M36x2	M33x2	28	28	38.5	31	52	47	36	41	41	621	160	
QADDH-14-14-12OG	M14x1.5	M12x1.5	06	06	22	15	32	30	14	17	17	71	400	
QADDH-16-16-14OG	M16x1.5	M14x1.5	08	08	24	17	36	32	19	19	19	91	400	
QADDH-18-18-16OG	M18x1.5	M16x1.5	10	10	25.5	18	38	34	19	22	22	124	400	
QADDH-20-20-18OG	M20x1.5	M18x1.5	12	12	28.5	21	43	38	22	24	24	160	400	
QADDH-24-24-22OG	M24x1.5	M22x1.5	16	16	33.5	25	49	43	27	30	27	213	400	
QADDH-30-30-27OG	M30x2	M27x2	20	20	38.5	28	55	49	30	36	32	409	400	
QADDH-36-36-33OG	M36x2	M33x2	25	25	42	30	60	54	36	46	41	657	350	
QADDH-42OG	M42x2	M42x2	30	30	49.5	36	68	62	46	50	50	1006	250	

注：如需带卡套及卡套螺母整套订货，则请在代号后加“RN”，如QADDH-18-18-16OG/RN；

如需配挡圈请在代号后加“DQ”，如QADDH-18-18-16OGDQ。

Note: In case if you are interested to order the adapter in complete set with cutting ring and nut, it is necessary to insert suffix “RN” after our part No., for example QADDH-18-18-16OG/RN;

with retainer ring please insert suffix “DQ” after our part No., for example QADDH-18-18-16OGDQ

过渡接头 ADAPTER 公制 DIN 卡套式 METRIC Thread Bite Type Tube Fitting

QACCG-OG, QADDG-OG QACCG-OG/RN, QADDG-OG/RN

英管螺纹可调向O型圈密封柱端主支三通
BSP Thread Adjustable Stud Ends With O-ring Sealing Run Tee

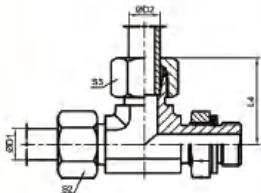
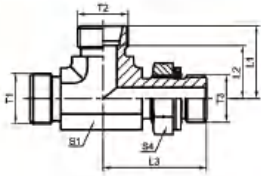

代号 PART NO.	螺纹 THREAD		管子外径		尺寸 DIMENSIONS							重量 克/件	工作压力 (bar)	系列
	T1/T2	T3	D1	D2	L1	L2	L3	L4	S1	S2/S3	S4			
QACCG-12-12-02OG	M12x1.5	G1/8"x28	06	06	21	14	26	29	14	14	14	44	200	L
QACCG-14-14-04OG	M14x1.5	G1/4"x19	08	08	23	16	32	31	14	17	19	68	200	
QACCG-16-16-04OG	M16x1.5	G1/4"x19	10	10	24	17	34	32	19	19	19	85	200	
QACCG-18-18-06OG	M18x1.5	G3/8"x19	12	12	26	19	37	34	19	22	22	125	200	
QACCG-22-22-08OG	M22x1.5	G1/2"x14	15	15	28	21	43	36	22	27	27	205	200	
QACCG-26-26-08OG	M26x1.5	G1/2"x14	18	18	31.5	24	49	40	27	32	27	266	200	
QACCG-30-30-12OG	M30x2	G3/4"x14	22	22	35.5	28	49	44	30	36	32	400	200	
QACCG-36-36-16OG	M36x2	G1"x11	28	28	38.5	31	59	47	36	41	41	637	200	
QACCG-45-45-20OG	M45x2	G1.1/4"x11	35	35	48.5	38	65	59	50	50	50	995	160	
QADDG-14-14-04OG	M14x1.5	G1/4"x19	06	06	22	15	32	30	14	17	19	72	315	
QADDG-16-16-04OG	M16x1.5	G1/4"x19	08	08	24	17	36	32	19	19	19	87	315	
QADDG-18-18-06OG	M18x1.5	G3/8"x19	10	10	25.5	18	38	34	19	22	22	127	315	
QADDG-20-20-06OG	M20x1.5	G3/8"x19	12	12	28.5	21	38	38	22	24	22	145	315	
QADDG-22-22-08OG	M22x1.5	G1/2"x14	14	14	31	23	43	41	22	27	27	213	250	
QADDG-24-24-08OG	M24x1.5	G1/2"x14	16	16	33.5	25	49	43	27	30	27	234	250	
QADDG-30-30-12OG	M30x2	G3/4"x14	20	20	38.5	28	51	49	30	36	36	413	250	
QADDG-36-36-16OG	M36x2	G1"x11	25	25	42	30	58	54	36	46	41	673	250	
QADDG-42-42-20OG	M42x2	G1.1/4"x11	30	30	49.5	36	64	62	46	50	50	1013	160	

注：如需带卡套及卡套螺母整套订货，则请在代号后加“RN”，如QADDG-18-18-06OG/RN；

如需配挡圈请在代号后加“DQ”，如QADDG-18-18-06OGDQ。

Note: In case if you are interested to order the adapter in complete set with cutting ring and nut, it is necessary to insert suffix "RN" after our part No., for example QADDG-18-18-06OG/RN;

with retainer ring please insert suffix "DQ" after our part No., for example QADDG-18-18-06OGDQ

QACCO-OG, QADDO-OG QACCO-OG/RN, QADDO-OG/RN

美制螺纹可调向O型圈密封柱端 主支三通
UN, UNF Thread Adjustable Stud Ends With O-Ring Sealing Run Tee

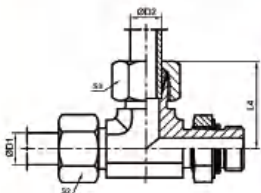
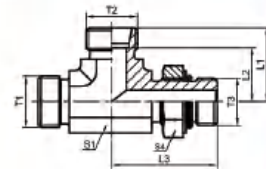

代号 PART NO.	螺纹 THREAD		管子外径		尺寸 DIMENSIONS							重量 克/件	工作压力 (bar)	系列
	T1/T2	T3	D1	D2	L1	L2	L3	L4	S1	S2/S3	S4			
QACCO-12-12-04OG	M12x1.5	7/16"x20	06	06	21	14	29	29	14	14	14	53	315	L
QACCO-14-14-06OG	M14x1.5	9/16"x18	08	08	22.5	15.5	31.8	30.5	14	17	17	72	250	
QACCO-16-16-06OG	M16x1.5	9/16"x18	10	10	24	17	34	32	19	19	17	90	250	
QACCO-18-18-08OG	M18x1.5	3/4"x16	12	12	26	19	38	34	19	22	22	142	250	
QACCO-22-22-10OG	M22x1.5	7/8"x14	15	15	28	21	43	36	22	27	27	212	200	
QACCO-26-26-12OG	M26x1.5	1.1/16"x12	18	18	31.5	24	49	40	30	32	32	333	200	
QACCO-30-30-12OG	M30x2	1.1/16"x12	22	22	35.5	28	53	44	30	36	32	410	200	
QACCO-36-36-16OG	M36x2	1.5/16"x12	28	28	38.5	31	59	47	36	41	41	642	160	
QACCO-45-45-20OG	M45x2	1.5/8"x12	35	35	48.5	38	63	59	46	50	50	1047	125	
QADDO-14-14-04OG	M14x1.5	7/16"x20	06	06	22	15	32	30	14	17	14	66	400	
QADDO-16-16-06OG	M16x1.5	9/16"x18	08	08	24	17	37	32	19	19	17	92	400	
QADDO-18-18-06OG	M18x1.5	9/16"x18	10	10	25.5	18	38	34	19	22	17	110	400	
QADDO-20-20-08OG	M20x1.5	3/4"x16	12	12	28.5	21	44	38	22	24	22	167	400	
QADDO-22-22-10OG	M22x1.5	7/8"x14	14	14	31	23	44	41	22	27	27	220	400	
QADDO-24-24-10OG	M24x1.5	7/8"x14	16	16	33.5	25	50	43	27	30	27	263	400	
QADDO-30-30-12OG	M30x2	1.1/16"x12	20	20	38.5	28	56	49	30	36	32	423	400	
QADDO-36-36-16OG	M36x2	1.5/16"x12	25	25	42	30	69	56.8	36	46	41	678	315	
QADDO-42-42-20OG	M42x2	1.5/8"x12	30	30	49.5	36	69	62	46	50	50	1007	250	

注：如需带卡套及卡套螺母整套订货，则请在代号后加“RN”，如QACCO-30-30-12OG/RN。

Note: In case if you are interested to order the adapter in complete set with cutting ring and nut, it is necessary to insert suffix "RN" after our part No., for example QACCO-30-30-12OG/RN.

过渡接头 ADAPTER 公制 DIN 卡套式 METRIC Thread Bite Type Tube Fitting

QACGC-OG, QADGD-OG QACGC-OG/RN, QADGD-OG/RN

英管螺纹可调向O型圈密封柱端分支三通 BSP Thread Adjustable Stud Ends With O-ring Sealing Branch Tee

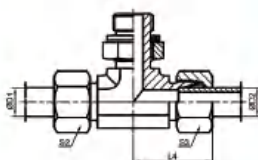
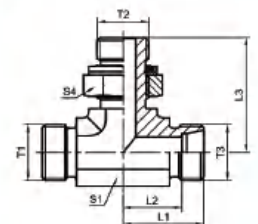

代号 PART NO.	螺纹 THREAD		管子外径		尺寸 DIMENSIONS								重量 克/件	工作压力 (bar)	系列
	T1/T3	T2	D1	D2	L1	L2	L3	L4	S1	S2/S3	S4				
QACGC-12-02-12OG	M12x1.5	G1/8"x28	06	06	21	14	26	29	14	14	14	44	500	L	
QACGC-14-04-14OG	M14x1.5	G1/4"x19	08	08	23	16	32	31	14	17	19	68	500		
QACGC-16-04-16OG	M16x1.5	G1/4"x19	10	10	24	17	34	32	19	19	19	85	500		
QACGC-18-06-18OG	M18x1.5	G3/8"x19	12	12	26	19	37	34	19	22	22	125	400		
QACGC-22-08-22OG	M22x1.5	G1/2"x14	15	15	28	21	43	36	22	27	27	205	400		
QACGC-26-08-26OG	M26x1.5	G1/2"x14	18	18	31.5	24	49	40	27	32	27	266	400		
QACGC-30-12-30OG	M30x2	G3/4"x14	22	22	35.5	28	49	44	30	36	32	400	250	S	
QACGC-36-16-36OG	M36x2	G1"x11	28	28	38.5	31	59	49	36	41	41	637	250		
QACGC-45-20-45OG	M45x2	G1.1/4"x11	35	35	48.5	38	65	59	46	50	50	995	250		
QADGD-14-04-14OG	M14x1.5	G1/4"x19	06	06	22	15	32	30	14	17	19	72	800		
QADGD-16-04-16OG	M16x1.5	G1/4"x19	08	08	24	17	36	32	19	19	19	87	800		
QADGD-18-06-18OG	M18x1.5	G3/8"x19	10	10	25.5	18	38	34	19	22	22	127	800		
QADGD-20-06-20OG	M20x1.5	G3/8"x19	12	12	28.5	22	38	38	22	24	22	145	630		
QADGD-22-08-22OG	M22x1.5	G1/2"x14	14	14	31	23	43	41	22	27	27	213	630		
QADGD-24-08-24OG	M24x1.5	G1/2"x14	16	16	33.5	25	49	43	27	30	27	234	630		
QADGD-30-12-30OG	M30x2	G3/4"x14	20	20	38.5	28	51	49	30	36	36	413	420		
QADGD-36-16-36OG	M36x2	G1"x11	25	25	42	30	58	54	36	46	41	673	420		
QADGD-42-20-42OG	M42x2	G1.1/4"x11	30	30	49.5	36	64	62	46	50	50	1013	420		

注：如需带卡套及卡套螺母整套订货，则请在代号后加“RN”，如QADGD-18-06-18OG/RN；
如需配挡圈请在代号后加“DQ”，如QADGD-18-06-18OGDQ。
Note: In case if you are interested to order the adapter in complete set with cutting ring and nut, it is necessary to insert suffix "RN" after our part No., for example QADGD-18-06-18OG/RN; with retainer ring please insert suffix "DQ" after our part No., for example QADGD-18-06-18OGDQ

QACHC-OG, QADHD-OG QACHC-OG/RN, QADHD-OG/RN

公制外螺纹可调向柱端 ISO 6149 分支三通 Metric Male Adjustable Stud Ends ISO 6149 Branch Tee

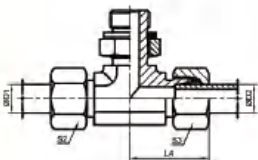
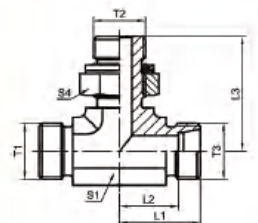

代号 PART NO.	螺纹 THREAD		管子外径		尺寸 DIMENSIONS								重量 克/件	工作压力 (bar)	系列
	T1/T3	T2	D1	D2	L1	L2	L3	L4	S1	S2/S3	S4				
QACHC-12-10-12OG	M12x1.5	M10x1	06	06	21	14	27	29	14	14	14	45	315	L	
QACHC-14-12-14OG	M14x1.5	M12x1.5	08	08	23	16	32	31	14	17	17	68	315		
QACHC-16-14-16OG	M16x1.5	M14x1.5	10	10	24	17	34	32	19	19	19	89	315		
QACHC-18-16-18OG	M18x1.5	M16x1.5	12	12	26	19	35	34	19	22	22	121	250		
QACHC-22-18-22OG	M22x1.5	M18x1.5	15	15	28	21	41	36	22	27	24	177	250		
QACHC-26-22-26OG	M26x1.5	M22x1.5	18	18	31.5	24	44	40	27	32	27	263	250		
QACHC-30-27-30OG	M30x2	M27x2	22	22	35.5	28	49	44	30	36	32	396	160	S	
QACHC-36-33-36OG	M36x2	M33x2	28	28	38.5	31	52	47	36	41	41	621	160		
QADHD-14-12-14OG	M14x1.5	M12x1.5	06	06	22	15	32	30	14	17	17	71	400		
QADHD-16-14-16OG	M16x1.5	M14x1.5	08	08	24	17	36	32	19	19	19	91	400		
QADHD-18-16-18OG	M18x1.5	M16x1.5	10	10	25.5	18	38	34	19	22	22	124	400		
QADHD-20-18-20OG	M20x1.5	M18x1.5	12	12	28.5	21	43	38	22	24	24	160	400		
QADHD-24-22-24OG	M24x1.5	M22x1.5	16	16	33.5	25	49	43	27	30	27	213	400		
QADHD-30-27-30OG	M30x2	M27x2	20	20	38.5	28	55	49	30	36	32	409	400		
QADHD-36-33-36OG	M36x2	M33x2	25	25	42	30	60	54	36	46	41	657	350		
QADHD-42OG	M42x2	M42x2	30	30	49.5	36	68	62	46	50	50	1006	250		

注：如需带卡套及卡套螺母整套订货，则请在代号后加“RN”，如QADHD-16-14-16OG/RN；
如需配挡圈请在代号后加“DQ”，如QADHD-16-14-16OGDQ。
Note: In case if you are interested to order the adapter in complete set with cutting ring and nut, it is necessary to insert suffix "RN" after our part No., for example QADHD-16-14-16OG/RN; with retainer ring please insert suffix "DQ" after our part No., for example QADHD-16-14-16OGDQ

过渡接头 ADAPTER 公制 DIN 卡套式 METRIC Thread Bite Type Tube Fitting

QACOC-OG,QADOD-OG

QACOC-OG/RN,QADOD-OG/RN

美制螺纹可调向O型圈密封柱端分支三通
UN,UNF Thread Adjustable Stud Ends With O-Ring Sealing Branch Tee

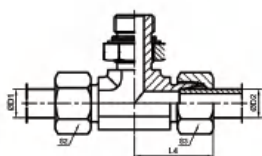
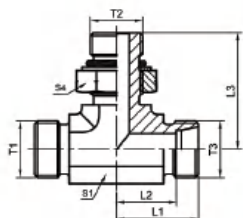

代号 PART NO.	螺纹 THREAD		管子外径		尺寸 DIMENSIONS								重量 克/件	工作压力 (bar)	系列
	T1/T3	T2	D1	D2	L1	L2	L3	L4	S1	S2,S3	S4				
QACOC-12-04-12OG	M12x1.5	7/16"x20	06	06	21	14	29	29	14	14	14	53	315	L	
QACOC-14-06-14OG	M14x1.5	9/16"x18	08	08	22.5	15.5	29	30.5	14	17	17	72	250		
QACOC-16-06-16OG	M16x1.5	9/16"x18	10	10	24	17	34	32	19	19	17	90	250		
QACOC-18-08-18OG	M18x1.5	3/4"x16	12	12	26	19	38	34	19	22	22	142	250		
QACOC-22-10-22OG	M22x1.5	7/8"x14	15	15	28	21	41	36	22	27	27	212	200		
QACOC-26-12-26OG	M26x1.5	1.1/16"x12	18	18	31.5	24	47	40	30	32	32	333	200		
QACOC-30-12-30OG	M30x2	1.1/16"x12	22	22	35.5	28	52	44	30	36	32	410	200		
QACOC-36-16-36OG	M36x2	1.5/16"x12	28	28	38.5	31	59	47	36	41	41	642	160		
QACOC-45-20-45OG	M45x2	1.5/8"x12	35	35	48.5	38	63	59	46	50	50	1047	125		
QADOD-14-04-14OG	M14x1.5	7/16"x20	06	06	22	15	32	30	14	17	14	66	400	S	
QADOD-16-06-16OG	M16x1.5	9/16"x18	08	08	24	17	37	32	19	19	17	92	400		
QADOD-18-06-18OG	M18x1.5	9/16"x18	10	10	25.5	18	38	34	19	22	17	110	400		
QADOD-20-08-20OG	M20x1.5	3/4"x16	12	12	28.5	22	44	38	22	24	22	167	400		
QADOD-22-10-22OG	M22x1.5	7/8"x14	14	14	31	23	44	41	22	27	27	220	400		
QADOD-24-10-24OG	M24x1.5	7/8"x14	16	16	33.5	25	50	43	27	30	27	263	400		
QADOD-30-12-30OG	M30x2	1.1/16"x12	20	20	38.5	28	56	49	30	36	32	423	400		
QADOD-36-16-36OG	M36x2	1.5/16"x12	25	25	44.8	32.8	57.5	56.8	36	46	41	678	315		
QADOD-42-20-42OG	M42x2	1.5/8"x12	30	30	49.5	36	69	62	46	50	50	1007	250		

注：如需带卡套及卡套螺母整套订货，则请在代号后加“RN”，如QACOC-30-12-30OG/RN。
Note: In case if you are interested to order the adapter in complete set with cutting ring and nut, it is necessary to insert suffix "RN" after our part No., for example QACOC-30-12-30OG/RN.

过渡接头 ADAPTER

公制 DIN 卡套式
METRIC Thread Bite Type Tube Fitting

Q1CT9-SP,Q1DT9-SP
Q1CT9-SP/RN,Q1DT9-SP/RN

90°弯英锥管外螺纹
90°Elbow BSPT Male

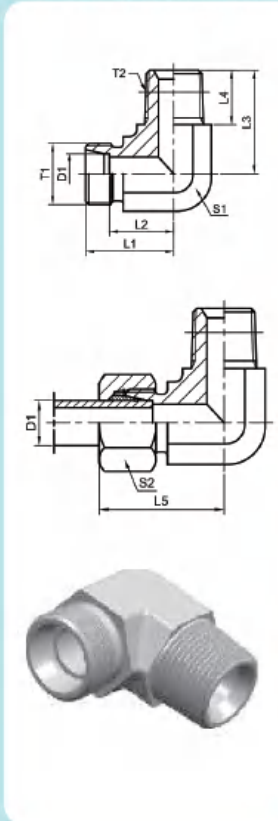

代号 PART NO.	螺纹 THREAD		管子外径 D1	尺寸 DIMENSIONS								重量 克/件	工作压力 (bar)	系列
	T1	T2		L1	L2	L3	L4	L5	S1	S2				
Q1CT9-12-02SP	M12x1.5	R1/8"x28	06	19	12	20	9.5	27	12	14	30	315	L	
Q1CT9-12-04SP	M12x1.5	R1/4"x19	06	21	14	26	12	29	12	14	47	315		
Q1CT9-14-04SP	M14x1.5	R1/4"x19	08	21	14	26	14	29	14	17	46	315		
Q1CT9-14-02SP	M14x1.5	R1/8"x28	08	21	14	26	9.5	29	14	17	49	315		
Q1CT9-14-06SP	M14x1.5	R3/8"x19	08	24	17	28	14	32	19	17	94	315		
Q1CT9-16-04SP	M16x1.5	R1/4"x19	10	22	15	27	14	30	17	19	61	315		
Q1CT9-16-06SP	M16x1.5	R3/8"x19	10	24	17	28	14	32	19	19	87	315		
Q1CT9-18-06SP	M18x1.5	R3/8"x19	12	24	17	28	14	32	19	22	88	315		
Q1CT9-18-04SP	M18x1.5	R1/4"x19	12	24	17	27	14	32	19	22	80	315		
Q1CT9-18-08SP	M18x1.5	R1/2"x14	12	28	21	34	14	36	19	22	89	315		
Q1CT9-22-08SP	M22x1.5	R1/2"x14	15	28	21	34	14	36	22	27	94	315		
Q1CT9-26-08SP	M26x1.5	R1/2"x14	18	31	23.5	36	17	40	27	32	141	315		
Q1DT9-14-04SP	M14x1.5	R1/4"x19	06	23	16	26	14	31	14	17	56	400	S	
Q1DT9-14-06SP	M14x1.5	R3/8"x19	06	25	18	20	12	33	19	17	61	400		
Q1DT9-16-04SP	M16x1.5	R1/4"x19	08	24	17	27	14	32	17	19	73	400		
Q1DT9-16-06SP	M16x1.5	R3/8"x19	08	25	18	28	12	33	19	19	63	400		
Q1DT9-18-06SP	M18x1.5	R3/8"x19	10	25	17.5	28	14	34	19	22	104	400		
Q1DT9-18-04SP	M18x1.5	R1/4"x19	10	25	17.5	28	14	34	19	22	59	400		
Q1DT9-18-08SP	M18x1.5	R1/2"x14	10	30	22.5	32	14	39	22	22	98	400		
Q1DT9-20-06SP	M20x1.5	R3/8"x19	12	29	21.5	28	14	38	19	24	126	400		
Q1DT9-20-08SP	M20x1.5	R1/2"x14	12	30	22.5	32	14	39	24	24	97	400		
Q1DT9-22-08SP	M22x1.5	R1/2"x14	14	30	22	32	14	40	22	27	101	400		
Q1DT9-24-08SP	M24x1.5	R1/2"x14	16	33	24.5	32	17	43	24	30	150	400		

注：如需带卡套及卡套螺母整套订货，则请在代号后加“RN”，如Q1CT-30-12SP/RN。
Note: In case if you are interested to order the adapter in complete set with cutting ring and nut, it is necessary to insert suffix "RN" after our part No.,for example Q1CT-30-12SP/RN.

过渡接头 ADAPTER 公制 DIN 卡套式 METRIC Thread Bite Type Tube Fitting

Q1CN9,Q1DN9
Q1CN9/RN,Q1DN9/RN

90°弯布锥管外螺纹
90°Elbow NPT Male

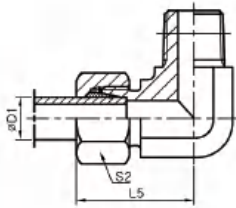
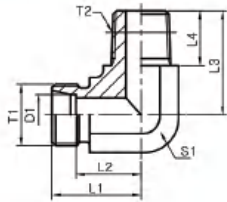

代号 PART NO.	螺纹 THREAD		管子外径 D1	尺寸 DIMENSIONS								重量 克/件	工作压力 (Bar)	系列
	T1	T2 T2		L1	L2	L3	L4	L5	S1	S2				
Q1CN9-12-02	M12x1.5	NPT 1/8"x27	06	19	12	20	10	27	12	14	29	315	L	
Q1CN9-12-04	M12x1.5	NPT 1/4"x18	06	21	14	26	14.5	29	12	14	44	315		
Q1CN9-12-06	M12x1.5	NPT 3/8"x18	06	25	18	28	14.5	33	17	14	55	315		
Q1CN9-14-02	M14x1.5	NPT 1/8"x27	08	21	14	26	10	29	12	17	48	315		
Q1CN9-14-04	M14x1.5	NPT 1/4"x18	08	21	14	26	14.5	29	12	17	47	315		
Q1CN9-16-04	M16x1.5	NPT 1/4"x18	10	22	15	27	14.5	30	14	19	61	315		
Q1CN9-16-06	M16x1.5	NPT 3/8"x18	10	24	17	28	14.5	32	17	19	92	315		
Q1CN9-18-04	M18x1.5	NPT 1/4"x18	12	24	17	28	14.5	32	17	22	82	315		
Q1CN9-18-06	M18x1.5	NPT 3/8"x18	12	24	17	28	14.5	32	17	22	92	315		
Q1CN9-18-08	M18x1.5	NPT 1/2"x14	12	28	21	34	19.5	36	19	22	90	315		
Q1CN9-22-08	M22x1.5	NPT 1/2"x14	15	28	21	34	19.5	36	19	27	89	315		
Q1CN9-26-08	M26x1.5	NPT 1/2"x14	18	31	23.5	36	19.5	40	24	32	150	315		
Q1CN9-30-12	M30x2	NPT 3/4"x14	22	35	27.5	42	19.5	44	27	36	176	160		
Q1CN9-36-16	M36x2	NPT 1"x11.5	28	38	30.5	48	24.5	47	36	41	314	160		
Q1CN9-45-20	M45x2	NPT 1.1/4"x11.5	35	45	34.5	54	25	56	46	50	465	160		
Q1CN9-52-24	M52x2	NPT 1.1/2"x11.5	42	51	40	61	26	63	50	60	849	160		
Q1DN9-14-04	M14x1.5	NPT 1/4"x18	06	23	16	26	14.5	31	12	17	56	630		
Q1DN9-16-04	M16x1.5	NPT 1/4"x18	08	24	17	27	14.5	32	14	19	73	630		
Q1DN9-16-06	M16x1.5	NPT 3/8"x18	08	25	18	28	14.5	33	17	19	77	630		
Q1DN9-16-08	M16x1.5	NPT 1/2"x14	08	30	23	34	19.5	38	19	19	75	630		
Q1DN9-18-04	M18x1.5	NPT 1/4"x18	10	25	17.5	28	14.5	34	17	22	96	630		
Q1DN9-18-06	M18x1.5	NPT 3/8"x18	10	25	17.5	28	14.5	34	17	22	98	630		
Q1DN9-20-06	M20x1.5	NPT 3/8"x18	12	30	22.5	28	14.5	38	19	24	123	630		
Q1DN9-20-08	M20x1.5	NPT 1/2"x14	12	30	22.5	34	19.5	39	19	24	107	630		
Q1DN9-22-08	M22x1.5	NPT 1/2"x14	14	30	22	34	19.5	40	19	27	103	630		
Q1DN9-24-08	M24x1.5	NPT 1/2"x14	16	33	24.5	36	19.5	43	24	30	157	400		
Q1DN9-30-12	M30x2	NPT 3/4"x14	20	37	26.5	42	19.5	48	27	36	205	400		
Q1DN9-36-16	M36x2	NPT 1"x11.5	25	42	30	48	24.5	54	36	46	381	400		
Q1DN9-42-20	M42x2	NPT 1.1/4"x11.5	30	49	35.5	54	25	62	41	50	598	400		
Q1DN9-52-24	M52x2	NPT 1.1/2"x11.5	38	57	41	61	26	72	50	60	1029	315		

注：如需带卡套及卡套螺母整套订货，则请在代号后加“RN”，如Q1CN9-30-12-300G/RN。
Note: In case if you are interested to order the adapter in complete set with cutting ring and nut, it is necessary to insert suffix "RN" after our part No., for example Q1CN9-30-12-300G/RN.

Q1CW,Q1DW
Q1CW/RN,Q1DW/RN

焊接接头
Weld Fittings

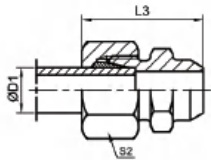
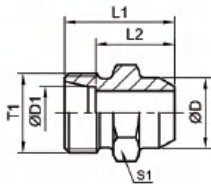

代号 PART NO.	螺纹 THREAD	管子外径 D1	尺寸 DIMENSIONS						重量 克/件	工作压力 (bar)	系列
	T1		D	L1	L2	L3	S1	S2			
Q1CW-12-06	M12x1.5	6	10	21	14	29	12	14	11	315	L
Q1CW-14-08	M14x1.5	8	12	23	16	31	14	17	15	315	
Q1CW-16-10	M16x1.5	10	14	25	18	33	17	19	22	315	
Q1CW-18-12	M18x1.5	12	16	25	18	33	19	22	25	315	
Q1CW-22-15	M22x1.5	15	19	29	22	37	22	27	44	315	
Q1CW-26-18	M26x1.5	18	22	31	23.5	40	27	32	67	315	
Q1CW-30-22	M30x2	22	27	36	28.5	45	32	36	98	160	
Q1CW-36-28	M36x2	28	32	38	30.5	47	41	41	165	160	
Q1CW-45-35	M45x2	35	40	43	32.5	54	46	50	232	160	
Q1CW-52-42	M52x2	42	46	46	35	58	55	60	342	160	
Q1DW-14-06	M14x1.5	6	11	26	19	34	14	17	21	630	S
Q1DW-16-08	M16x1.5	8	13	28	21	36	17	19	31	630	
Q1DW-18-10	M18x1.5	10	15	30	22.5	39	19	22	41	630	
Q1DW-20-12	M20x1.5	12	17	32	24.5	41	22	24	93	630	
Q1DW-22-14	M22x1.5	14	19	35	27	45	24	27	55	630	
Q1DW-24-16	M24x1.5	16	21	35	26.5	45	27	30	82	400	
Q1DW-30-20	M30x2	20	26	40	29.5	51	32	36	131	400	
Q1DW-36-25	M36x2	25	31	44	32	56	41	46	219	400	
Q1DW-42-30	M42x2	30	36	49	35.5	62	46	50	297	400	
Q1DW-52-38	M52x2	38	44	54	38	69	55	60	448	315	

注：如需带卡套及卡套螺母整套订货，则请在代号后加“RN”，如Q1CW-30-22/RN。

Note: In case if you are interested to order the adapter in complete set with cutting ring and nut, it is necessary to insert suffix "RN" after our part No., for example Q1CW-30-22/RN.

过渡接头 ADAPTER 公制 DIN 卡套式 METRIC Thread Bite Type Tube Fitting

Q2WC,Q2WD

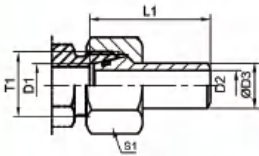

焊接接头 Weld Fittings

代号 PART NO.	螺纹 THREAD T1	管子外径 TUBE O·D D1	尺寸 DIMENSIONS					重量 克/件	工作压力 (bar)	系列
			L1	D2	D3		S1			
Q2WC-6X1.5	M12x1.5	06	31.5	3	06		14	7	528	L
Q2WC-8X2.0	M14x1.5	08	31.5	4	08		17	11	528	
Q2WC-10X2.0	M16x1.5	10	33.5	6	10		19	16	460	
Q2WC-12X2.0	M18x1.5	12	33.5	8	12		22	20	393	
Q2WC-15X2.0	M22x1.5	15	34.5	11	15		27	29	305	
Q2WC-18X2.0	M26x1.5	18	36.5	14	18		32	38	315	
Q2WC-22X2.0	M30x2	22	39.5	18	22		36	55	160	
Q2WC-28X2.5	M36x2	28	42.5	23	28		41	73	160	
Q2WC-35X3.0	M45x2	35	49.5	29	35		50	89	160	
Q2WC-42X3.0	M52x2	42	50	36	42		60	155	160	
Q2WD-6X1.5	M14x1.5	06	31.5	3	06		17	7	528	S
Q2WD-8X2.0	M16x1.5	08	31.5	4	08		19	11	528	
Q2WD-10X1.0	M18x1.5	10	33.5	8	10		22	13	249	
Q2WD-10X1.5	M18x1.5	10	33.5	7	10		22	13	358	
Q2WD-10X2.0	M18x1.5	10	33.5	6	10		22	16	460	
Q2WD-12X1.5	M20x1.5	12	33.5	9	12		24	21	305	
Q2WD-12X2.0	M20x1.5	12	33.5	8	12		24	21	393	
Q2WD-12X2.5	M20x1.5	12	33.5	7	12		24	22	476	
Q2WD-14X2.0	M22x1.5	14	39.5	10	14		27	26	343	
Q2WD-14X3.0	M22x1.5	14	39.5	8	14		27	33	487	
Q2WD-16X1.5	M24x1.5	16	40.5	13	16		30	32	234	
Q2WD-16X2.0	M24x1.5	16	40.5	12	16		30	31	305	
Q2WD-16X2.5	M24x1.5	16	40.5	11	16		30	38	372	
Q2WD-16X3.0	M24x1.5	16	40.5	10	16		30	41	400	
Q2WD-20X2.0	M30x2	20	47	16	20		36	57	249	
Q2WD-20X2.5	M30x2	20	47	15	20		36	57	305	
Q2WD-20X3.0	M30x2	20	47	14	20		36	64	358	
Q2WD-20X3.5	M30x2	20	47	13	20		36	71	400	
Q2WD-20X4.0	M30x2	20	47	12	20		36	78	400	
Q2WD-25X3.0	M36x2	25	53	19	25		46	89	294	
Q2WD-25X3.5	M36x2	25	53	18	25		46	100	337	
Q2WD-25X4.0	M36x2	25	53	17	25		46	111	379	
Q2WD-25X5.0	M36x2	25	53	15	25		46	125	400	
Q2WD-30X3.0	M42x2	30	57	24	30		50	113	249	
Q2WD-30X4.0	M42x2	30	57	22	30		50	141	323	
Q2WD-30X5.0	M42x2	30	57	20	30		50	166	393	
Q2WD-30X6.0	M42x2	30	57	18	30		50	188	400	
Q2WD-38X3.0	M52x2	38	64	32	38		60	163	200	
Q2WD-38X4.0	M52x2	38	64	30	38		60	209	261	
Q2WD-38X5.0	M52x2	38	64	28	38		60	247	315	
Q2WD-38X6.0	M52x2	38	64	26	38		60	270	315	
Q2WD-38X7.0	M52x2	38	64	24	38		60	270	315	

过渡接头 ADAPTER 公制 DIN 卡套式 METRIC Thread Bite Type Tube Fitting

Q1CFL, Q1DFL Q1CFL-ZH/RN, Q1DFL-ZH/RN

DIN卡套式/SAE法兰 Metric Male Bite Type/ SAE Flange 3000 PSI系列

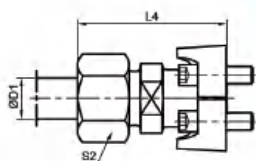
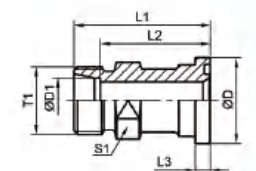

代号 PART NO.	螺纹 THREAD T1	管子外径 TUBE O.D. D1	尺寸 DIMENSIONS								重量 克/件	工作压力 (bar)	系列
			D	L1	L2	L3	L4	S1	S2				
Q1CFL-22-08	M22x1.5	15	30.2	48	41	6.7	56	24	27	360	315	L	
Q1CFL-26-08	M26x1.5	18	30.2	50	42.5	6.7	61	24	32	420	315		
Q1CFL-26-12	M26x1.5	18	38.1	53	45.5	6.7	62	30	32	590	315		
Q1CFL-30-12	M30x2	22	38.1	53	45.5	6.7	62	30	36	590	160		
Q1CFL-36-12	M36x2	28	38.1	55	45.5	6.7	64	32	41	600	160		
Q1CFL-36-16	M36x2	28	44.5	54	46.5	8	63	36	41	730	160		
Q1CFL-45-20	M45x2	35	50.8	58	47.5	8	69	41	50	1020	160		
Q1CFL-45-24	M45x2	35	60.3	65	54.5	8	76	46	50	1200	160		
Q1CFL-52-24	M52x2	42	60.3	64	53	8	76	46	60	1360	160		
Q1DFL-24-08	M24x1.5	16	30.2	50	41.5	6.7	60	24	30	400	350		S
Q1DFL-24-12	M24x1.5	16	38.1	55	46.5	6.7	64.5	27	30	520	350		
Q1DFL-30-12	M30x2	20	38.1	57	46.5	6.7	68	30	36	650	350		
Q1DFL-36-12	M36x2	25	38.1	57	45	6.7	69	30	46	780	350		
Q1DFL-30-16	M30x2	20	44.5	60	48.5	8	71	32	36	700	350		
Q1DFL-36-16	M36x2	25	44.5	58	46.5	8	60	36	46	840	350		
Q1DFL-42-16	M42x2	30	44.5	63	49.5	8	76	36	50	940	200		
Q1DFL-36-20	M36x2	25	50.8	60	48	8	72	41	46	1170	200		
Q1DFL-42-20	M42x2	30	50.8	62	48.5	8	75	41	50	1200	200		
Q1DFL-52-20	M52x2	38	50.8	66	50	8	81	46	60	1410	200		
Q1DFL-52-24	M52x2	38	60.3	70	54	8	85	46	60	1630	200		

注：需配法兰夹和螺钉在代号后加“ZH”，如Q1CFL-36-16ZH

Note In case if you are interestad to order adapter in complete set with split flange clamps and screw it is nexessary to insert suffix "ZH" after our part NO, for example Q1CFL-36-16ZH

Q1DFS Q1DFS-ZH/RN

DIN卡套式/SAE法兰 Metric Male Bite Type/ SAE Flange 6000 PSI 系列

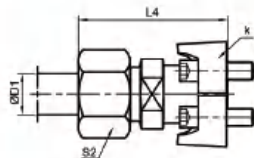
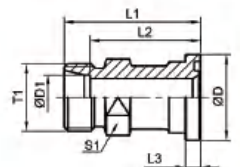

代号 PART NO.	螺纹 THREAD T1	管子外径 D1	尺寸 DIMENSIONS								螺栓	重量 克/件	工作压力 (bar)	系列
			D	L1	L2	L3	L4	S1	S2					
Q1DFS-20-08	M20x1.5	12	31.8	42.5	42.5	7.7	57.5	19	24	M8X30	350	420	S	
Q1DFS-22-08	M22x1.5	14	31.8	50	42	7.7	59.5	19	27	M8X30	390	420		
Q1DFS-24-08	M24x1.5	16	31.8	53	44.5	7.7	63	24	30	M8X30	470	400		
Q1DFS-24-12	M24x1.5	16	41.3	59	50.5	8.7	69	30	30	M10X35	790	400		
Q1DFS-30-12	M30x2	20	41.3	61	50.5	8.7	72	30	36	M10X35	860	400		
Q1DFS-36-12	M36x2	25	41.3	63	51	8.7	75	30	46	M10X35	970	400		
Q1DFS-42-12	M42x2	30	41.3	76	62	8.7	89	30	50	M10X35	1150	420		
Q1DFS-30-16	M30x2	20	47.6	75	64.5	9.5	88	36	36	M12X45	970	420		
Q1DFS-36-16	M36x2	25	47.6	72	60	9.5	84	36	46	M12X45	1420	400		
Q1DFS-42-16	M42x2	30	47.6	74	60.5	9.5	87	36	50	M12X45	1400	400		
Q1DFS-52-16	M52x2	38	47.6	84.5	68	9.5	99	46	60	M12X45	1400	315		
Q1DFS-36-20	M36x2	25	54	80	68	10.2	92	41	46	M14X50	1850	420		
Q1DFS-42-20	M42x2	30	54	79	65.5	10.2	92	41	50	M14X50	1900	400		
Q1DFS-52-20	M52x2	38	54	83	67	10.2	98	46	60	M14X50	2100	315		
Q1DFS-42-24	M42x2	30	63.5	90	74	12.5	103	46	50	M16X55	2100	420		
Q1DFS-52-24	M52x2	38	63.5	89	73	12.5	104	46	60	M16X55	3060	315		

注：如需配法兰夹和螺钉在代号后加“ZH”，如Q1DFS-36-16ZH

Note In case if you are interestad to order adapter in complete set with split flange clamps and screw it is nexessary to insert suffix "ZH" after our part NO, for example Q1DFS-36-16ZH

过渡接头 ADAPTER 公制 DIN 卡套式 METRIC Thread Bite Type Tube Fitting

Q1CFL9, Q1DFL9
Q1CFL9-ZH/RN, Q1DFL9-ZH/RN

90°弯DIN卡套式/SAE法兰
90°Metric Male Bite Type/SAE Flange
3000 PSI 系列

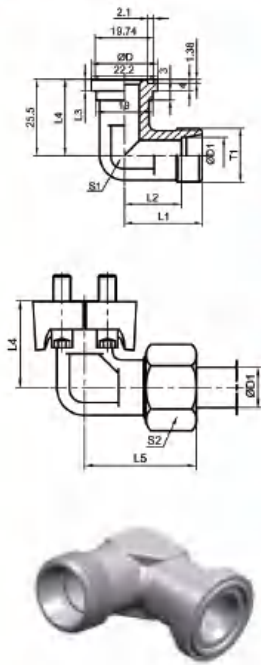

代号 PART NO.	螺纹 THREAD T1	管子外径		尺寸 DIMENSIONS							螺栓	重量 克/件	工作压力 (bar)	系列
		D1	D	L1	L2	L3	L4	L5	S1	S2				
Q1CFL9-22-08	M22x1.5	15	30.2	36	29	6.7	36	44	24	27	M8X25	400	315	L
Q1CFL9-26-08	M26x1.5	18	30.2	37	29.5	6.7	36	46	24	32	M8X25	440	315	
Q1CFL9-26-12	M26x1.5	18	38.1	39	31.5	6.7	42	48	30	32	M10X30	660	315	
Q1CFL9-30-12	M30x2	22	38.1	41	33.5	6.7	42	50	30	36	M10X30	660	160	
Q1CFL9-36-12	M36x2	28	38.1	41	33.5	6.7	42	50	30	41	M10X30	780	160	
Q1CFL9-30-16	M30x2	22	44.5	65	57.5	8	60	74	34	36	M10X30	810	160	
Q1CFL9-36-16	M36x2	28	44.5	44	36.5	8	45	53	36	41	M10X30	850	160	
Q1CFL9-45-20	M45x2	35	50.8	57	46.5	8	50	68	41	50	M10X35	1150	160	
Q1CFL9-45-24	M45x2	35	60.3	78	67.5	8	55	83	50	50	M10X35	1550	160	
Q1CFL9-52-24	M52x2	42	60.3	58	47	8	55	70	50	60	M12X35	1600	160	
Q1DFL9-20-08	M20x1.5	12	30.2	50	42.5	6.7	36	58.5	22	24	M8X25	380	210	S
Q1DFL9-24-08	M24x1.5	16	30.2	38	29.5	6.7	36	48	24	30	M8X25	430	350	
Q1DFL9-24-12	M24x1.5	16	38.1	64	55.5	6.7	43	73.5	27	30	M10X30	600	350	
Q1DFL9-30-12	M30x2	20	38.1	43	32.5	6.7	42	54	30	36	M10X30	760	350	
Q1DFL9-36-12	M36x2	25	38.1	45	33	6.7	42	57	30	46	M10X30	890	350	
Q1DFL9-30-16	M30x2	20	44.5	65	54.5	8	45	77	36	36	M10X30	780	350	
Q1DFL9-36-16	M36x2	25	44.5	48	36.5	8	45	57	36	46	M10X30	950	350	
Q1DFL9-42-16	M42x2	30	44.5	50	36.5	8	45	63	36	50	M10X30	1060	350	
Q1DFL9-36-20	M36x2	25	50.8	55	43	8	50	67	41	46	M10X35	1350	280	
Q1DFL9-42-20	M42x2	30	50.8	57	43.5	8	50	71	41	50	M10X35	1400	280	
Q1DFL9-52-20	M52x2	38	50.8	59	43	8	50	74	41	60	M10X35	1530	280	
Q1DFL9-52-24	M52x2	38	60.3	64	48	8	55	79	50	60	M10X35	1950	210	

注: 如需配法兰夹和螺钉在代号后加“ZH”, 如Q1DFL9-36-ZH
Note In case if you are interested to order adapter in complete set with split flange clamps and screw it is necessary to insert suffix "ZH" after our part NO, for example Q1DFSL9-36-ZH

Q1DFS9
Q1DFS9-ZH/RN

90°弯DIN卡套式/SAE法兰
90°Metric Male Bite Type/SAE Flange
6000 PSI 系列

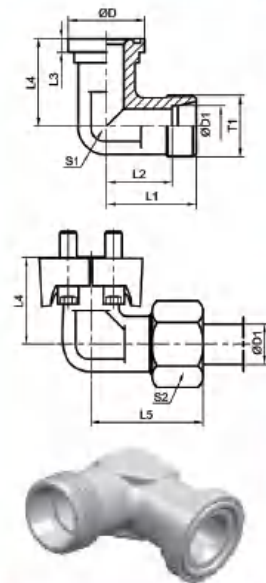

代号 PART NO.	螺纹 THREAD T1	管子外径		尺寸 DIMENSIONS							螺栓	重量 克/件	工作压力 (bar)	系列
		D1	D	L1	L2	L3	L4	L5	S1	S2				
Q1DFS9-20-08	M20x1.5	12	31.8	50	42.5	7.7	39	58.5	22	24	M8X30	370	420	S
Q1DFS9-22-08	M22x1.5	14	31.8	50	42	7.7	39	59.5	22	27	M8X30	390	420	
Q1DFS9-24-08	M24x1.5	16	31.8	38	29.5	7.7	39	48	24	30	M8X30	490	400	
Q1DFS9-24-12	M24x1.5	16	41.3	45	36.5	8.7	48	55	32	30	M10X35	920	400	
Q1DFS9-30-12	M30x2	20	41.3	46	35.5	8.7	48	57	32	36	M10X35	970	400	
Q1DFS9-36-12	M36x2	25	41.3	48	36	8.7	48	60	32	46	M10X35	1110	400	
Q1DFS9-30-16	M30x2	20	47.6	65	54.5	9.5	60	75	41	36	M12X45	1690	420	
Q1DFS9-36-16	M36x2	25	47.6	53	44	9.5	60	65	41	46	M12X45	1670	400	
Q1DFS9-42-16	M42x2	30	47.6	55	41.5	9.5	60	68	41	50	M12X45	1630	400	
Q1DFS9-36-20	M36x2	25	54	64	52	10.2	68	76	42	46	M14X50	2230	420	
Q1DFS9-42-20	M42x2	30	54	58	44.5	10.2	68	71	46	50	M14X50	2220	400	
Q1DFS9-52-20	M52x2	38	54	61	45	10.2	68	76	46	60	M14X50	2390	315	
Q1DFS9-42-24	M42x2	30	63.5	76	63.5	12.5	76	90	50	50	M16X55	2380	420	
Q1DFS9-52-24	M52x2	38	63.5	72	56	12.5	76	87	50	60	M16X55	2580	315	

注: 如需配法兰夹和螺钉在代号后加“ZH”, 如Q1DFS9-36-ZH
Note In case if you are interested to order adapter in complete set with split flange clamps and screw it is necessary to insert suffix "ZH" after our part NO, for example Q1DFS9-36-ZH

Q1CFG,Q1DFG

泵油口方形法兰接头
Pump Flange Connection

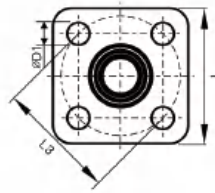
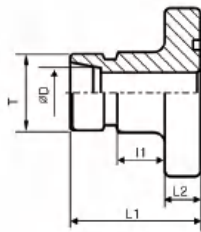

代号 PART NO.	螺纹 THREAD	管子外径 TUDE O.D.	尺寸 DIMENSIONS					配件附件		工作压力 Mpa
	T1		L	L1	L2	L3	D1	螺栓 BOLT	O型圈 O-RING	
QICFG-16-30	M16X1.5	10	36	30	8	30	6.5	4XM6X22	20X2.5	31.5
QICFG-18-30	M18X1.5	12	36	30	8	30	6.5	4XM6X22	20X2.5	31.5
QICFG-16-35	M16X1.5	10	39	30	8	35	6.5	4XM6X22	20X2.5	31.5
QICFG-18-35	M18X1.5	12	39	30	8	35	6.5	4XM6X22	20X2.5	31.5
QICFG-22-35	M22X1.5	15	39	30	8	35	6.5	4XM6X22	20X2.5	25
QICFG-26-35	M26X1.5	18	39	30	8	35	6.5	4XM6X22	20X2.5	25
QICFG-22-40	M22X1.5	15	42	35	8	40	6.5	4XM6X22	20X2.5	10
QICFG-26-40	M26X1.5	18	42	35	8	40	6.5	4XM6X22	20X2.5	10
QICFG-30-40	M30X2	22	42	35	8	40	6.5	4XM6X22	20X2.5	10
QICFG-36-40	M36X2	28	42	42	8	40	6.5	4XM6X22	20X2.5	10
QIDFG-24-35	M24X1.5	16	39	30	8	35	6.5	4XM6X22	20X2.5	31.5
QIDFG-30-55	M30X2	20	55	42	8	55	8.5	4XM8X22	32X2.5	25

Q1CFG9,Q1DFG9

泵油口90°弯方形法兰接头
90° Elow Pump Flange Connection

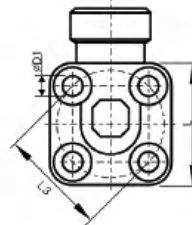
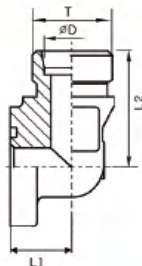

代号 PART NO.	螺纹 THREAD	管子外径 TUDE O.D.	尺寸 DIMENSIONS					配件附件		工作压力 Mpa
	T1		L	L1	L2	L3	D1	螺栓 BOLT	O型圈 O-RING	
QICFG9-16-35	M16X1.5	10	39	16.5	38	35	6.5	M6X22/M6X35	20X2.5	31.5
QICFG9-18-35	M18X1.5	12	39	16.5	38	35	6.5	M6X22/M6X35	20X2.5	31.5
QICFG9-22-35	M22X1.5	15	39	16.5	38	35	6.5	M6X22/M6X35	20X2.5	25
QICFG9-26-35	M26X1.5	18	39	20.5	38	35	6.5	M6X22/M6X40	20X2.5	25
QICFG9-22-40	M22X1.5	15	42	22.5	38	40	6.5	M6X22/M6X40	26X2.5	10
QICFG9-26-35	M26X1.5	18	42	22.5	38	40	6.5	M6X22	20X2.5	10
QICFG9-30-40	M30X2	22	42	22.5	38	40	6.5	M6X22	26X2.5	10
QICFG9-36-40	M36X2	28	42	28	40	40	6.5	M6X22/M6X50	26X2.5	10
QICFG9-45-40	M45X2	35	42	34	41	40	6.5	M6X22/M6X60	26X2.5	10
QIDFG9-24-35	M24X1.5	16	39	20	38	35	6.5	M6X22/M6X40	20X2.5	31.5
QIDFG9-30-35	M30X2	20	39	25	45	35	6.5	M6X22/M6X45	20X2.5	31.5
QIDFG9-30-40	M30X2	20	42	22.5	40	40	6.5	M6X22/M6X45	26X2.5	25

过渡接头 ADAPTER

公制 DIN 卡套式
METRIC Thread Bite Type Tube Fitting

Q1CI-KDS
Q1DI-KDS
KDS垫圈

Q1CI-KDS/RN
Q1DI-KDS/RN
KDS垫圈

Q1CI-GDK/RN
Q1DI-GDK/RN
GDK钢垫圈

高压铰接式接头公制螺纹弹性密封
High Pressure Metric Banjo Elastic Seal

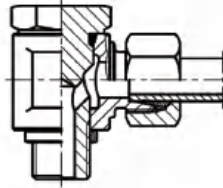
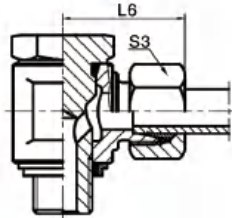
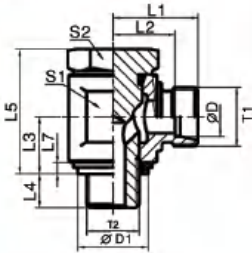

代号 PART NO.	螺纹 THREAD		管子外径 D TUBE O.D.	尺寸 DIMENSIONS													工作压力 Mpa
	T1	T2		L1	L2	L3	L4	L5	L6	L7	S1	S2	S3	D1(KDS)	D1(GDK)		
Q1CI-12-10KDS	M12X1.5	M10X1	06	19	12	10.5	8	24	27	2.5	17	17	14	14.9	14	31.5	
Q1CI-14-12KDS	M14X1.5	M12X1.5	08	21.5	14.5	14	12	30	29	3.0	22	19	17	17	17	31.5	
Q1CI-16-14KDS	M16X1.5	M14X1.5	10	22.5	15.5	14	12	30	30	3.0	22	19	19	18.9	19	31.5	
Q1CI-18-16KDS	M18X1.5	M16X1.5	12	25	18.0	16.5	12	36	33	3.0	27	24	22	21.9	21	31.5	
Q1CI-22-18KDS	M22X1.5	M18X1.5	15	27.5	21.5	18.5	12	39.5	37	3.0	30	30	27	23.9	23	31.5	
Q1CI-26-22KDS	M26X1.5	M22X1.5	18	28.5	21	21.5	14	45	37	4.5	32	30	32	26.9	27	31.5	
Q1CI-30-26KDS	M30X2	M26X1.5	22	35	27.5	24	16	53	44	3.5	41	36	36	31.9	31	16	
Q1CI-36-33KDS	M36X2	M33X2	28	39.5	32	30.5	18	66	49	3.5	50	46	41	39.9	39	16	
Q1CI-45-42KDS	M45X2	M42X2	35	46.5	36	35.5	20	76	58	3.5	60	55	50	49.9	49	16	
Q1CI-52-48KDS	M52X2	M48X2	42	51.5	40.5	40.5	22	87	63	3.5	70	60	60	55.9	55	16	
Q1DI-14-12KDS	M14X1.5	M12X1.5	06	23.5	16.5	14	12	30	31	3.0	22	19	17	17	17	40	
Q1DI-16-14KDS	M16X1.5	M14X1.5	08	23.5	16.5	14	12	30	31	3.0	22	19	19	18.9	19	40	
Q1DI-18-16KDS	M18X1.5	M16X1.5	10	26	18.5	16.5	12	36	35	3.0	27	24	22	21.9	21	40	
Q1DI-20-18KDS	M20X1.5	M18X1.5	12	27.5	20	18.5	12	39.5	36	3.0	27	27	24	23.9	23	40	
Q1DI-22-20KDS	M22X1.5	M20X1.5	14	30.5	22.5	20	14	43.5	40	3.0	32	30	27	32	25	40	
Q1DI-24-22KDS	M24X1.5	M22X1.5	16	30.5	22	21.5	14	45	40	4.5	32	30	30	26.9	27	31.5	
Q1DI-30-27KDS	M30X2	M27X2	20	37	26.5	24	16	53	48	3.5	41	36	36	32.9	32	31.5	
Q1DI-36-33KDS	M36X2	M33X2	25	43.5	31.5	30.5	18	66	56	3.5	50	46	46	39.9	39	25	
Q1DI-42KDS	M42X2	M42X2	30	50.5	37	35.5	20	76	64	3.5	60	55	50	49.9	49	16	
Q1DI-52-48KDS	M52X2	M48X2	38	57.5	41.5	40.5	22	87	72	3.5	70	60	60	55.9	55	16	

注：如需带卡套及卡套螺母整套订货，则请在代号后加“RN”，如Q1CI-30-26KDS/RN。

Note: In case if you are interested to order the adapter in complete set with cutting ring and nut, it is necessary to insert suffix "RN" after our part No., for example Q1CI-30-26KDS/RN.



沧州乾程液压器材有限公司
CANGZHOU QC HYDRAULICS CO., LTD

Q1CI-B-KDS
Q1DI-B-KDS
KDS垫圈

Q1CI-B-KDS/RN
Q1DI-B-KDS/RN
KDS垫圈

Q1CI-B-GDK/RN
Q1DI-B-GDK/RN
GDK钢垫圈

高压铰接式接头英制螺纹弹性密封
High Pressure BSP Banjo Elastic Seal

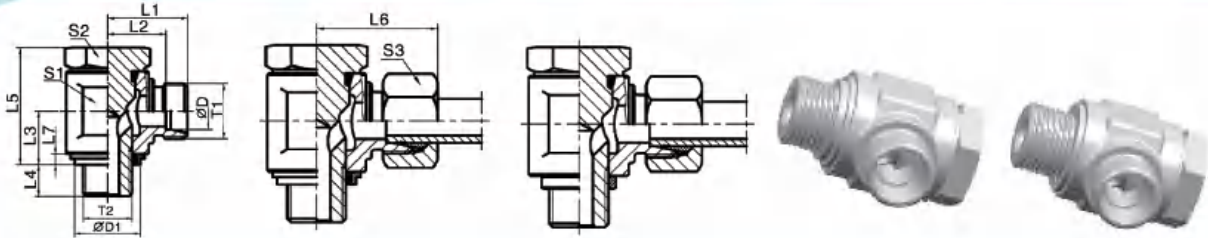

代号 PART NO.	螺纹 THREAD		管子外径 TUBE O.D.	尺寸 DIMENSIONS											工作压力 Mpa
	T1	T2		L1	L2	L3	L4	L5	L6	L7	D1	S1	S2	S3	
Q1CI-12-B02KDS	M12X1.5	G1/8" X28	06	19	12	10.5	8	24	27	2.5	14.9	17	17	14	31.5
Q1CI-14-B04KDS	M14X1.5	G1/4" X19	08	21.5	14.5	14	12	30	29	3.0	18.9	22	19	17	31.5
Q1CI-16-B04KDS	M16X1.5	G1/4" X19	10	22.5	15.5	14	12	30	30	3.0	18.9	22	19	19	31.5
Q1CI-18-B06KDS	M18X1.5	G3/8" X19	12	25	18.0	16.5	12	36	33	3.0	21.9	27	24	22	31.5
Q1CI-22-B08KDS	M22X1.5	G1/2" X14	15	28.5	21.5	21.5	14	45	37	4.5	26.9	32	30	27	31.5
Q1CI-26-B08KDS	M26X1.5	G1/2" X14	18	28.5	21	21.5	14	45	37	4.5	26.9	32	30	32	31.5
Q1CI-30-B12KDS	M30X2	G3/4" X14	22	35	27.5	24	16	53	44	3.5	32.9	41	36	36	16
Q1CI-36-B16KDS	M36X2	G1" X11	28	39.5	32	30.5	18	66	49	3.5	39.9	50	46	41	16
Q1CI-45-B20KDS	M45X2	G1.1/4" X11	35	46.5	36	35.5	20	76	58	3.5	49.9	60	55	50	16
Q1CI-52-B24KDS	M52X2	G1.1/2" X11	42	51.5	40.5	40.5	22	87	63	3.5	55.9	70	60	60	16
Q1DI-14-B04KDS	M14X1.5	G1/4" X19	06	23.5	16.5	14	12	30	31	3.0	18.9	22	19	17	40
Q1DI-16-B04KDS	M16X1.5	G1/4" X19	08	23.5	16.5	14	12	30	31	3.0	18.9	22	19	19	40
Q1DI-18-B06KDS	M18X1.5	G3/8" X19	10	26	18.5	16.5	12	36	35	3.0	21.9	27	24	22	40
Q1DI-20-B06KDS	M20X1.5	G3/8" X19	12	26	18.5	16.5	12	36	35	3.0	21.9	27	24	24	40
Q1DI-22-B08KDS	M22X1.5	G1/2" X14	14	30.5	22.5	21.5	15	45	40	4.5	26.9	32	30	27	40
Q1DI-24-B08KDS	M24X1.5	G1/2" X14	16	30.5	22	21.5	14	45	40	4.5	26.9	32	30	30	31.5
Q1DI-30-B12KDS	M30X2	G3/4" X14	20	37	26.5	24	16	53	48	3.5	32.9	41	36	36	31.5
Q1DI-36-B16KDS	M36X2	G1" X11	25	43.5	31.5	30.5	18	66	56	3.5	39.9	50	46	46	25
Q1DI-42-B20KDS	M42X2	G1.1/4" X11	30	50.5	37	35.5	20	76	64	3.5	49.9	60	55	50	16
Q1DI-52-B24KDS	M52X2	G1.1/2" X11	38	57.5	41.5	40.5	22	87	72	3.5	55.9	70	60	60	16

注：如需带卡套及卡套螺母整套订货，则请在代号后加“RN”，如Q1CI-30-B12KDS/RN。

Note: In case if you are interested to order the adapter in complete set with cutting ring and nut, it is necessary to insert suffix "RN" after our part No., for example Q1CI-30-B12KDS/RN.

过渡接头 ADAPTER 公制 DIN 卡套式 METRIC Thread Bite Type Tube Fitting

Q4C,Q4D Q4C/RN,Q4D/RN

堵头 Plug

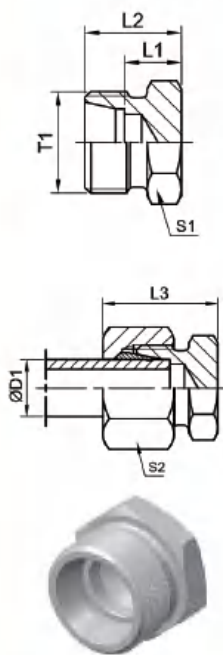

代号 PART NO.	螺纹 THREAD T1	管子外径 D1	尺寸 DIMENSIONS						重量 克/件	工作压力 (bar)	系列
			L1	L2	L3	S1	S2				
4C-12	M12x1.5	06	7	14	22	12	14	8	500	L	
4C-14	M14x1.5	08	8	15	23	14	17	13	500		
4C-16	M16x1.5	10	9	16	24	17	19	17	500		
4C-18	M18x1.5	12	10	17	25	19	22	24	400		
4C-22	M22x1.5	15	11	18	26	24	27	41	400		
4C-26	M26x1.5	18	11.5	19	28	27	32	56	400		
4C-30	M30x2	22	13.5	21	30	32	36	84	250		
4C-36	M36x2	28	14.5	22	31	41	41	138	250		
4C-45	M45x2	35	14.5	25	36	46	50	203	250		
4C-52	M52x2	42	16	27	39	55	60	318	250		
4D-14	M14x1.5	06	11	18	26	14	17	17	800	S	
4D-16	M16x1.5	08	13	20	28	17	19	28	800		
4D-18	M18x1.5	10	14.5	20	29	19	22	33	800		
4D-20	M20x1.5	12	14.5	22	31	22	24	50	630		
4D-22	M22x1.5	14	16	24	34	24	27	62	630		
4D-24	M24x1.5	16	15.5	24	34	27	30	75	630		
4D-30	M30x2	20	17.5	28	39	32	36	125	420		
4D-36	M36x2	25	20	32	44	41	46	229	420		
4D-42	M42x2	30	20.5	34	47	46	50	310	420		
4D-52	M52x2	38	23	39	54	55	60	805	420		

注：如需带卡套及卡套螺母整套订货，则请在代号后加“RN”，如Q4C-30/RN。

Note: In case if you are interested to order the adapter in complete set with cutting ring and nut, it is necessary to insert suffix "RN" after our part No., for example Q4C-30/RN.

Q9C,Q9D

内螺纹堵头 Female Plug

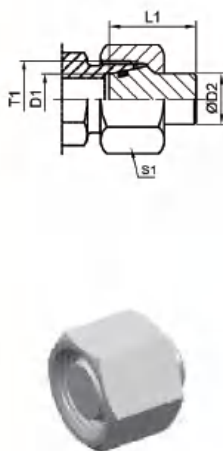

代号 PART NO.	螺纹 THREAD T1	管子外径 D1	尺寸 DIMENSIONS						重量 克/件	工作压力 (bar)	系列
			L1	D2	S1						
Q9C-12	M12x1.5	06	18.5	06	14				15	500	L
Q9C-14	M14x1.5	08	18.5	08	17				24	500	
Q9C-16	M16x1.5	10	20	10	19				33	500	
Q9C-18	M18x1.5	12	20.5	12	22				46	400	
Q9C-22	M22x1.5	15	20.5	15	27				73	400	
Q9C-26	M26x1.5	18	22.5	18	32				111	400	
Q9C-30	M30x2	22	25	22	36				162	250	
Q9C-36	M36x2	28	25.5	28	41				220	250	
Q9C-45	M45x2	35	30	35	50				376	250	
Q9C-52	M52x2	42	30	42	60				558	250	
Q9D-14	M14x1.5	06	18.5	06	17				23	800	S
Q9D-16	M16x1.5	08	18.5	08	19				29	800	
Q9D-18	M18x1.5	10	20	10	22				46	800	
Q9D-20	M20x1.5	12	20.5	12	24				55	630	
Q9D-22	M22x1.5	14	22.5	14	27				83	630	
Q9D-24	M24x1.5	16	23.5	16	30				106	630	
Q9D-30	M30x2	20	28.5	20	36				180	420	
Q9D-36	M36x2	25	29	25	46				322	420	
Q9D-42	M42x2	30	30.5	30	50				398	420	
Q9D-52	M52x2	38	33	38	60				647	420	

卡套螺母
Retaining Nuts

QNL,QNS

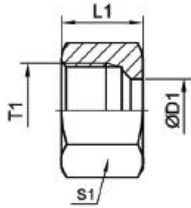

代号 PART NO.	螺纹 THREAD T1	管子外径 TUBE O.D	尺寸 DIMENSIONS				重量 克/件	系列
			L1	D1	S1			
QNL-12	M12X1.5	06	15	06		14	10	L
QNL-14	M14X1.5	08	15	08		17	15	
QNL-16	M16X1.5	10	16	10		19	18	
QNL-18	M18X1.5	12	16	12		22	25	
QNL-22	M22X1.5	15	17.5	15		27	42	
QNL-26	M26X1.5	18	18.5	18		32	62	
QNL-30	M30X2	22	20.5	22		36	82	
QNL-36	M36X2	28	21	28		41	89	
QNL-45	M45X2	35	24	35		50	137	
QNL-52	M52X2	42	24	42		60	216	
QNS-14	M14X1.5	06	17	06		17	17	S
QNS-16	M16X1.5	08	17	08		19	20	
QNS-18	M18X1.5	10	18	10		22	31	
QNS-20	M20X1.5	12	18	12		24	34	
QNS-22	M22X1.5	14	21	14		27	53	
QNS-24	M24X1.5	16	21	16		30	66	
QNS-30	M30X2	20	24.5	20		36	102	
QNS-36	M36X2	25	27	25		46	202	
QNS-42	M42X2	30	29	30		50	219	
QNS-52	M52X2	38	32.5	38		60	339	

卡套
Cutting ring

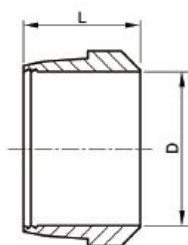

QRL
QRS

系列 SERIES	代号 RAPT NO.	管子外径 ϕ O.D.	尺寸 DIMENSIONS	重量 克/件	最大工作压力 (bar)
		D	L		
L	QRL-06	06	9	1.7	315
	QRL-08	08	9	2.2	315
	QRL-10	10	9.5	3.1	315
	QRL-12	12	9.8	3.5	315
	QRL-15	15	9.5	4.5	315
	QRL-18	18	9.5	5.5	315
	QRL-22	22	10.5	7.3	160
	QRL-28	28	11.5	9.4	160
	QRL-35	35	13.5	20	160
S	QRS-06	06	9	1.7	630
		08	9	3.2	630
	QRS-10	10	9.5	3.1	630
		12	9.8	3.5	630
	QRS-14	14	9.5	3.9	630
		16	9.5	5.6	400
	QRS-20	20	12.5	11.4	400
		25	12.5	13.3	400
	QRS-35	30	12.5	19.3	400
	38	13.5	22.5	315	



CANGZHOU QC HYDRAULICS CO., LTD

STAINLESS STEEL METRIC DIN 2353 TUBE FITTINGS

QC HYDRAULICS IS A STAINLESS STEEL MANUFACTURER



Tianzhuangzi Village, Zhifangtou Township, Cang County,
Cangzhou City, Hebei Province, China.

E-mail: info@qchydraulics.com

Tel: +86-317-4953899

Fax: +86-317-4953796

Website: <http://www.qchydraulics.com/>